

User manual

ROSSI
Welders



- ⚠ WARNING!** Read and understand all safety warnings and instructions carefully before using this machine. Failure to follow the warnings and instructions may result in electric shock, fire and/or serious injury. Save this manual for future reference.
- ⚠ ATTENTION!** Products covered by this manual will vary in appearance, assembly, inclusions, description and packaging.
- ⚠ NOTE!** This manual covers multiple product models. Some features, options and/or accessories may or may not be applicable to your specific model.



Index

Index	1
Safety	2
General Safety	12
Parts Diagram	13
Which welder do I need?	22
Types of Welding	22
ARC / Stick Welding	22
MIG Welding / Gas Metal Arc Welding (GMAW)	23
TIG Welding / Gas Tungsten Arc Welding (GTAW)	23
Pulsed TIG Welding	24
Plasma Cutting	25
Getting Started	26
TIG welding Basics	26
ARC Welding Basics	27
Installing MIG wire	28
Troubleshooting	31
Arc Welding Faults	33
Travel Speed Faults	33
Current Setting Faults	34
TIG Welding Faults	35
MIG Welding Faults	36
Plasma Cutting Faults	37
Specifications	38
Glossary	46

Safety

Only qualified persons should install, operate, maintain, and repair this unit.



ATTENTION! This manual is provided to assist the owner of the product to understand the functions it provides and how to prepare the equipment. This manual does not seek to teach the user how to perform the actual task it is used for. It is strongly recommended that a comprehensive training course on the machines use, safe handling and operation be completed before attempting to use this machine.



It is important you read and understand the instruction manual before use and keep the manual in a safe place for future reference.



Safety precautions must be observed to reduce the risk of personal injury when operating this machine.



It is strongly recommended that a comprehensive training course on machine use, handling and operation be completed before attempting to use this machine.



IMPORTANT! Like all power equipment this unit must be handled carefully.



DANGER! Electric Shock can kill.



DANGER! Exposure to fumes and gases can damage the lungs and respiratory system or cause asphyxiation.

Work area safety

Keep work area clean and well lit. Cluttered or dark areas invite accidents. Do not operate equipment in explosive atmospheres, such as in the presence of flammable liquids, gases or dust. Equipment creates sparks which may ignite. Keep children and bystanders away while operating equipment.

Personal safety

Stay alert, watch what you are doing and use common sense when operating equipment. Do not use equipment while you are tired or under the influence of drugs, alcohol or

medication. A moment of inattention while operating equipment may result in serious personal injury. Use personal protective equipment. Always wear eye protection. Protective equipment such as dust mask, non-skid safety shoes, hard hat, or hearing protection used for appropriate conditions will reduce personal injuries. Ensure the equipment is switched off before connecting to power source, picking up or carrying the equipment. Never carry equipment with your finger on the switches or trigger. Remove any adjusting key or wrench before turning the equipment on. Do not overreach. Keep proper footing and balance at all times. This enables better control of the equipment in unexpected situations. Dress properly. Do not wear loose clothing or jewellery. Keep your hair and clothing away from the work area. Loose clothes, jewellery or long hair can be caught in moving parts. If devices are provided for the connection of dust and fume extraction and collection facilities, ensure these are connected and properly used.

Equipment use and care

Do not force the equipment. Use the correct equipment for your application. The correct equipment will do the job better and safer at the rate for which it was designed. Do not use the equipment if it is found to be faulty, faulty equipment that cannot be controlled is dangerous and must be repaired. Disconnect the plug from the power source before making any adjustments, changing accessories, or storing equipment. Such preventive safety measures reduce the risk of starting the equipment accidentally. Store idle equipment out of the reach of children and do not allow persons unfamiliar with the equipment or these instructions to operate the equipment. Electrical equipment is dangerous in the hands of untrained users. Maintain equipment. Check for misalignment or

binding of moving parts, breakage of parts and any other condition that may affect the equipment's operation. If damaged, have the equipment repaired before use. Many accidents are caused by poorly maintained equipment. Use the equipment, accessories and tool bits etc. in accordance with these instructions, taking into account the working conditions and the work to be performed. Use of the equipment for operations different from those intended could result in a hazardous situation. Keep handles dry, clean and free from oil and grease. Slippery handles do not allow for safe handling and control of the tool in unexpected situations.

Electrical Safety.

Equipment plugs must match the outlet. Never modify the plug in any way. Do not use any adapter plugs with earthed (grounded) equipment. Touching live electrical parts can cause fatal shocks or severe burns. The electrode and work circuit is electrically live whenever the output is on. The input power circuit and machine internal circuits are also live when power is on. In semi-automatic or automatic wire welding, the wire, wire reel, drive roll housing, and all metal parts touching the welding wire are electrically live. Incorrectly installed or improperly grounded equipment is a hazard. Keep your gloves and other protective clothing, dry and free of oil and grease. Never coil or loop welding cables around your body. Do not touch live electrical parts.

Wear dry, hole-free insulating gloves and body protection. Insulate yourself from work and ground using dry insulating mats or covers big enough to prevent any physical contact with the work or ground. Do not use AC output in damp areas, if movement is confined, or if there is a danger of falling. Don't weld while standing on a wet surface or while standing in water. Use AC output ONLY if required for the welding process. If AC output is required, use remote output control if present on unit.

Additional safety precautions are required when any of the following electrically hazardous conditions are present: in damp locations or while

wearing wet clothing; on metal structures such as floors, gratings, or scaffolds; when in cramped positions such as sitting, kneeling, or lying; or when there is a high risk of unavoidable or accidental contact with the work piece or ground. For these conditions, use the following equipment in order presented: 1) a semiautomatic DC constant voltage (wire) welder, 2) a DC manual (stick) welder, or 3) an AC welder with reduced open-circuit voltage. In most situations, use of a DC, constant voltage wire welder is recommended. Do not work alone!

Disconnect input power before installing or servicing this equipment. Properly install, ground, and operate this equipment according to its Owner's Manual and national, state, and local codes. Always verify the supply ground – check and be sure that input power cord ground wire is properly connected to ground terminal in disconnect box or that cord plug is connected to a properly grounded receptacle outlet. When making input connections, attach proper grounding conductor first – double-check connections. Keep cords dry, free of oil and grease, and protected from hot metal and sparks. Frequently inspect input power cord for damage or bare wiring – replace cord immediately if damaged – bare wiring can kill. Turn off all equipment when not in use. Do not use worn, damaged, undersized, or poorly spliced cables. Do not drape cables over your body. If earth grounding of the work piece is required, ground it directly with a separate cable. Do not touch electrode if you are in contact with the work, ground, or another electrode from a different machine. Do not touch electrode holders connected to two welding machines at the same time since double open-circuit voltage will be present. Use only well-maintained equipment. Repair or replace damaged parts at once. Maintain unit according to manual. Wear a safety harness if working above floor level. Keep all panels and covers securely in place.

Clamp work cable with good metal-to-metal contact to work piece or worktable as near the weld as practical. Insulate work clamp when not connected to work piece to prevent contact with any metal object. Do not connect more than one electrode or work cable to any single weld output terminal. SIGNIFICANT DC VOLTAGE exists in inverter welding power sources AFTER removal of input power. Do not abuse the cord. Never use the cord for carrying, pulling or unplugging the equipment. Keep cord away from heat, oil, sharp edges or moving parts. Damaged or entangled cords increase the risk of electric shock. When operating equipment outdoors, use an extension cord suitable for outdoor use. Use of a cord suitable for outdoor use reduces the risk of electric shock. If operating equipment in a damp location

is unavoidable, use a residual current device (RCD) protected supply. Use of an RCD reduces the risk of electric shock. NOTE: The term “residual current device (RCD)” may be replaced by the term “ground fault circuit interrupter (GFCI)” or “earth leakage circuit breaker (ELCB)”.

Hot Parts can burn.

Don't touch hot parts bare handed. Allow cooling period before working on equipment. To handle hot parts, use proper tools and/or wear heavy, insulated welding gloves and clothing to prevent burns.

Fumes and Gases can be hazardous.

Welding produces fumes and gases. Breathing these fumes and gases can be hazardous to your health. Keep your head out of the fumes. Do not breathe the fumes. If inside, ventilate the area and/or use local forced ventilation at the arc to remove welding fumes and gases. If ventilation is poor, wear an approved air-supplied respirator. Read and understand the Material Safety Data Sheets (MSDSs) and the manufacturer's instructions for metals, consumables, coatings, cleaners, and degreasers. Work in a confined space only if it is well ventilated, or while wearing an air-supplied respirator. Always have a trained watch person nearby. Welding fumes and gases can displace air and lower the oxygen level causing injury or death. Be sure the breathing air is safe. Do not weld in locations near degreasing, cleaning, or spraying operations. The heat and rays of the arc can react with vapours to form highly toxic and irritating gases.

Do not weld on coated metals, such as galvanized, lead, or cadmium plated steel, unless the coating is removed from the weld area, the area is well ventilated, and while wearing an air-supplied respirator. The coatings and any metals containing these elements can give off toxic fumes if welded.

ARC Rays can burn eyes and skin.

Arc rays from the welding process produce intense visible and invisible (ultraviolet and infrared) rays that can burn eyes and skin. Sparks fly off from the weld. Wear an approved welding helmet fitted with a proper shade of filter lenses to protect your face and eyes from arc rays and sparks when welding or watching. Wear approved safety glasses with side shields under your helmet. Use protective screens or barriers to protect others from flash, glare and sparks; warn others not to watch the arc. Wear protective clothing made from durable, flame-resistant material (leather, heavy cotton, or wool) and foot protection.

Welding can cause fire or explosion.

Welding on closed containers, such as tanks, drums, or pipes, can cause them

to blow up. Sparks can fly off from the welding arc. The flying sparks, hot work piece, and hot equipment can cause fires and burns. Accidental contact of electrode to metal objects can cause sparks, explosion, overheating, or fire. Check and be sure the area is safe before doing any welding. Remove all flammables within 35 ft (10.7 m) of the welding arc. If this is not possible, tightly cover them with approved covers. Do not weld where flying sparks can strike flammable material.

Protect yourself and others from flying sparks and hot metal. Be alert that welding sparks and hot materials from welding can easily go through small cracks and openings to adjacent areas. Watch for fire, and keep a fire extinguisher nearby. Be aware that welding on a ceiling, floor, bulkhead, or partition can cause fire on the hidden side. Do not weld on containers that have held combustibles, or on closed containers such as tanks, drums, or pipes unless they are properly prepared according to AS 1674.1 and AS 1674.2 "Safety in Welding and Allied Processes". Do not weld where the atmosphere may contain flammable dust, gas, or liquid vapours (such as gasoline). Connect work cable to the work as close to the welding area as practical to prevent welding current from traveling long, possibly unknown paths and causing electric shock, sparks, and fire hazards. Do not use welder to thaw frozen pipes. Remove stick electrode from holder or cut off welding wire at contact tip when not in use. Wear oil-free protective garments such as leather gloves, heavy shirt, cuff-less trousers, high shoes, and a cap. Remove any combustibles, such as a butane lighter or matches, from your person before doing any welding. After completion of work, inspect area to ensure it is free of sparks, glowing embers, and flames. Use only correct fuses or circuit breakers. Do not oversize or bypass them. Always have a fire watcher and extinguisher nearby.

Eye Protection

Welding, chipping, wire brushing and grinding cause sparks and flying metal. As welds cool, they can throw off slag. Wear approved safety glasses with side shields even under your welding helmet. Flying Metal or Dirt can injure eyes.

Gas Safety

Build-up of gas can injure or kill. Shut off compressed gas supply when not in use. Always ventilate confined spaces or use approved respirator.

Electric and Magnetic Fields (EMP) can affect Implanted Medical Devices.

Wearers of Pacemakers and other Implanted Medical Devices should keep away. Implanted Medical Device wearers should consult their doctor and the device manufacturer before going near arc welding, spot welding, gouging, plasma arc cutting, or induction heating operations.

Ear Protection

Noise from some processes or equipment can damage hearing. Wear approved ear protection if noise level is high.

Cylinders can explode if damaged.

Compressed gas cylinders contain gas under high pressure. If damaged, a cylinder can explode. Since gas cylinders are normally part of the welding process, be sure to treat them carefully. Protect compressed gas cylinders from excessive heat, mechanical shocks, physical damage, slag, open flames, sparks, and arcs.

Install cylinders in an upright position by securing to a stationary support or cylinder rack to prevent falling or tipping. Keep cylinders away from any welding or other electrical circuits. Never drape a welding torch over a gas cylinder. Never allow a welding electrode to touch any cylinder. Never weld on a pressurized cylinder – explosion will result. Use only correct compressed gas cylinders, regulators, hoses, and fittings designed for the specific application; maintain them and associated parts in good condition. Turn face away from valve outlet when opening cylinder valve. Keep protective cap in place over valve except when cylinder is in use or connected for use.

Use the right equipment, correct procedures, and sufficient number of persons to lift and move cylinders. Refer to Australian Standard 4332-1995 "The storage and handling of gases in cylinders" for more detailed guidance on the location and construction of gas cylinder stores, including ventilation, operational and personnel safety and fire protection and other emergency measures.

Fire or Explosion Safety

Do not install or place unit on, over, or near combustible surfaces. Do not install unit near flammables. Do not overload building wiring – be sure power supply system is properly sized, rated, and protected to handle this unit.

Falling Equipment

Use lifting eye or handle to lift unit only, NOT running gear, gas cylinders, or any other accessories. Use equipment of adequate capacity to lift and support unit. If using lift forks to move unit, be sure forks are long enough to extend beyond opposite side of unit. Keep

equipment (cables and cords) away from moving vehicles when working from an aerial location.

Overuse can cause Overheating

Allow cooling period; follow rated duty cycle. Reduce current or reduce duty cycle before starting to weld again. Do not block or filter airflow to unit.

Flying Sparks can injure.

Wear a face shield to protect eyes and face. Shape tungsten electrode only on a grinder with proper guards in a safe location wearing proper face, hand, and body protection.

⚠ Sparks can cause fires — keep flammables away.

Moving Parts can injure.

Keep away from moving parts. Keep away from pinch points such as drive rolls.

Welding Wire can injure.

Do not press gun trigger until instructed to do so. Do not point gun toward any part of the body, other people, or any metal when threading welding wire.

Battery Explosion can injure.

Do not use welder to charge batteries or jump start vehicles unless it has a battery charging feature designed for this purpose.

Moving Parts can injure.

Keep away from moving parts such as fans. Keep all doors, panels, covers, and guards closed and securely in place. Have only qualified persons remove doors, panels, covers, or guards for maintenance and troubleshooting as necessary. Reinstall doors, panels, covers, or guards when maintenance is finished and before reconnecting input power.

EMF Information

Electric current flowing through any conductor causes localized electric and magnetic fields (EMF). Welding current creates an EMF field around the welding circuit and welding equipment. EMF fields may interfere with some medical implants, e.g. pacemakers. Protective measures for persons wearing medical implants have to be taken. For example, restrict access for passers-by or conduct individual risk assessment for welders. All welders should use the following procedures in order to minimize exposure to EMF fields from the welding circuit:

- Keep cables close together by twisting or taping them, or using a cable cover.
- Do not place your body between welding cables. Arrange cables to one side and away from the operator.
- Do not coil or drape cables around your body.
- Keep head and trunk as far away from the equipment in the welding circuit as possible.

- Connect work clamp to work piece as close to the weld as possible.
- Do not work next to, sit or lean on the welding power source.
- Do not weld whilst carrying the welding power source or wire feeder.

Implanted Medical Device wearers should consult their doctor and the device manufacturer before performing or going near arc welding, spot welding, gouging, plasma arc cutting, or induction heating operations. If cleared by your doctor, then following the above procedures is recommended.

Service

Have your equipment serviced by a qualified repair person using only identical replacement parts. This will ensure that the safety of the equipment is maintained.

Additional Safety requirements

This appliance is not intended for use by persons (including children) with reduced physical, sensory or mental capabilities, or lack of experience and knowledge. Never allow children to access the tool. If any non-consumable part is damaged, it must be replaced by the manufacturer, its service agent or similarly qualified persons in order to avoid a hazard. Read the instructions carefully. Be familiar with the controls and proper use of the equipment. Wear eye protection. Never allow children to access the machine. Avoid using the equipment, while people, especially children or pets, are nearby. Use the equipment only in daylight or good artificial light. Never operate the equipment with damaged guards or shields or without guards or shields in place. Use only the manufacturer's recommended replacement parts and accessories. Disconnect power from the equipment before carrying out maintenance or cleaning work. Inspect and maintain the tool regularly. Have the equipment repaired only by an authorized repairer. Always ensure that the ventilation openings are kept clear of debris. When not in use, store the equipment out of the reach of children. Before using the machine and after any impact, check for signs of wear or damage and repair as necessary.

Maintenance

When not in use store the machine out of the reach of children; After use, disconnect the equipment & check for damage; Use only manufacturers recommended replacement parts and accessories.

Warnings

Read the instructions carefully. Be familiar with the controls and proper use of the equipment. Welding Safety Welding and cutting are both specialist processes, and safety should always be the number one priority.

Arc Radiation

Arc radiation is a result of ULTRA-VIOLET (UV) and INFRA-RED (IR) RAYS and exposure can cause:

- Skin Cancer
- Thermal Skin Burns (severe sun burn)
- ARC FLASH (Welders Flash) or EYE BURN which can result in

inflammation of the cornea, cataracts or blindness.

A welding flash can occur by indirectly viewing the arc even for a relatively short time, for example:

1. Unconsciously looking out the corner of the eye
2. Looking away from the arc (close eyes then turn away).
3. Reflections of the arc from shiny surfaces in the welding area.

Advised Protection Required Includes:

- ⚠ An approved welding helmet with the correct filter and shade number.

- ⚠ Safety glasses which will help to refract (bend away) the UV and IR rays away, reducing the chances of Arc Flash.

Always wear protective full covering clothing to shield your body from potential burns, for example:

- Overalls-flame resistant wool or cotton.
- Leather apron or jacket.
- Always wear leather gloves.
- Skull cap (for overhead welding).
- Screen the welding zone when welding in open spaces.









WARNING

PROTECT YOURSELF
AND OTHERS

DO NOT REMOVE, DESTROY
OR COVER THIS LABEL

ARC WELDING AND CUTTING can be hazardous.

- Read and understand this label and the instruction manual before installing and operating this unit.
- Only qualified persons are to install, use or service this equipment according to the applicable codes and safety practices.
- Keep Children away
- Pacemaker wearers keep away
- It is strongly recommended that a comprehensive training course on use, safety and operation be completed before attempting to use this machine.

	<p>⚠ ELECTRIC SHOCK can kill.</p> <ul style="list-style-type: none"> • Always wear dry insulating gloves. • Insulate yourself from work and ground. • Connect Earth to workplace. • Do NOT touch live electrical parts • Disconnect input power before servicing unit. • Keep all panels and covers securely in place. • Replace all damaged insulating parts. • Turn off power source before working on torch. • Welding wire and drive parts may be at welding voltage. 		<p>⚠ FUMES AND GASES can be hazardous to our health.</p> <ul style="list-style-type: none"> • Keep your head out of the fumes. • Ventilate area or use breathing device. • Read Material Safety Data Sheet (MSDS) and manufacturer's instructions for material used.
	<p>⚠ ARC RAYS can burn eyes and skin, NOISE can damage hearing.</p> <ul style="list-style-type: none"> • Wear welding helmet with correct filter. • Wear eye, ear and body protection. 		<p>⚠ ARC CUTTING can cause injury.</p> <ul style="list-style-type: none"> • Keep away from torch tip. • Keep away from cutting path. • Turn off power source before working on torch. • Install torch nozzle before operating torch. • Use torch(es) specified in instruction manual or exactly matching what is supplied when new.
	<p>⚠ WELDING OR CUTTING can cause fire or explosion.</p> <ul style="list-style-type: none"> • Do NOT weld or cut near flammable material. • Watch for fire; keep extinguisher nearby. • Do NOT weld or cut closed containers. • Do NOT place unit on combustible surface. 		

*Read and understand the manufacturer's instructions and your employer's safety practices. For further information refer to AS 1674 and WITA technical note 7 or the manufacturers recommendations.

WARNING! Protect yourself and others. Read and understand this label. Electric shock can kill. Potentially lethal voltages may be present on the output of this equipment. Fumes and gases can be dangerous to your health. Arc radiation can injure eyes and burn skin. Read and understand the manufacturer's instructions and your employer's safety practices. Keep your head out of fumes. Use enough natural ventilation, exhaust ventilation, or both, at the fume source to keep fumes and gases from the breathing zone and the general area. Wear correct eye, ear and body protection. Do not touch live electrical parts. For further information refer to AS 1674 and WITA technical note 7 or the manufacturers recommendations.

DO NOT REMOVE THIS WARNING.

⚠ IMPORTANT! - Machine, Fuel handling or Electrical Safety; If you are not familiar with safe operation / handling of this machine, or are in any way unsure of any part of this products suitability or correct use for your application you should complete training conducted by a person or organisation qualified in safe use and training related to this product.



Some experts believe the use of almost any product could cause serious injury or death. For information that may reduce your risk of serious injury or death consult the points below and additionally, the information available at www.datastreamserver.com/safety

- Consult all documentation, packaging and product labelling before use. Note that some products feature online documentation which should be printed and kept with the product.
- Check product for loose/broken/damaged/missing parts, wear or leaks (if applicable) before each use. Never use a product with loose/broken/damaged/missing parts, wear or leaks (if applicable).
- Product must be inspected and serviced (if applicable) by a qualified specialist every 6 months assuming average residential use by a person of average weight and strength, above average technical aptitude, on a property matching average metropolitan specification. Intended use outside these guidelines could indicate the product is not suitable for intended use or may require more regular inspection or servicing.
- Ensure all possible users of the product have completed an industry recognised training course before being given access to the product.
- The product has been supplied by a general merchandise retailer that may not be familiar with your specific application or your description of the application. Be sure to attain third party approval for your application from a qualified specialist before use regardless of prior assurances by the retailer or it's representatives.
- This product is not intended for use where fail-safe operation is required. As with any product (take an automobile, aircraft, computer or ball point pen for example) there is always a small chance of a technical issue that needs to be repaired or may require replacement of the product or a part. If the possibility of such failure and the associated time it takes to rectify could in any situation inconvenience the user, business or employee or could financially affect the user, business or employee then the product is not suitable for your requirements. This product is not for use where incorrect operation or a failure of any kind, including but not limited to a condition requiring product return, replacement, service by a technician or replacement of parts could cause a financial loss, loss of employee time or an inconvenience requiring compensation.
- If this item has been purchased in error considering the points above simply contact the retailer directly for details of their returns policies if required.

⚠ DANGER! Fumes and gases are caused by the melting, vaporisation and other reactions of the consumables, base metals and gases (where applicable) involved in the welding arc.

Some common contaminants:

Iron Fume	Vaporisation of iron from base metal and electrode coatings.
Chromium	Stainless steel, electrode coatings, platings.
Nickel	Stainless steel, nickel-clad steel.
Zinc Fume	Vaporisation of zinc alloys, electrode coatings galvanised steel, zinc-primed steel.
Copper Fume	Vaporisation of coatings on electrode wires, sheaths on air carbon arc gouging electrodes, copper alloys.
Vanadium, Manganese, Molybdenum	Welding rods, alloying elements in steels.
Tin	Tin-coated steel, some nonferrous alloys.
Cadmium	Plating
Lead	Fluxes, coatings on electrodes, flux in wires
Carbon Monoxide	Combustion products of gas metal arc welding, air carbon arc gouging, oxyfuel flames; exhaust from car engines.
Ozone	Gas metal arc welding, air carbon arc gouging; titanium and aluminium welding in inert gas atmospheres
Nitrogen Dioxide	Gas metal arc welding; oxy fuel flame processes.
Phosgene	Welding of metal covered with chlorinated hydrocarbon solvents.

⚠ DANGER! Exposure to fumes and gases can damage the lungs and respiratory system or cause asphyxiation.

Advised Protection Required Includes:

- Adequate ventilation.
- Keep your head out of and away from the fumes.
- Use a welding fume respirator, or an air supplied respirator (especially in confined space).
- Use a fume extraction unit/or gun.

⚠ NOTE! Welding fume fever caused by breathing fumes formed by the welding of various metals can occur a few hours after exposure and can last several days.

Symptoms Include:

- Nausea
- Fatigue
- Fever
- Dry nose and throat
- Chills
- Metallic taste in mouth
- Weakness
- Joint and muscle pain

⚠ Note: If any of these symptoms are observed please seek professional medical attention.

Heat

⚠ WARNING! Extreme heat and sparks are created during welding and related processes. Operators are at continual risk of burns from hot surfaces/materials, sparks and radiated heat from the arc.

⚠ WARNING! Welding sparks can travel long distances and have been known to reach up to 15 metres away from the source of welding on the ground and even further when working in elevated positions.

⚠ DANGER! Sparks can reach combustible materials and start fires, as well as burning unprotected skin.

⚠ DANGER! Burns can result from handling hot just welded work (the most common of welding burns) and molten weld metal (spatter) falling or spitting onto exposed skin.

Advised Protection Required Includes:

- Always wear protective clothing.
- Keep safety glasses on your head where they belong.
- Always mark just welded work with the word “HOT”.
- Know where the nearest fire extinguisher or fire hose is and how to use them.
- Remove combustible materials away from the welding area. (at least 15 metres or 50 feet away).
- If in an elevated position, post a person on the ground as a fire-watcher.
- Never connect the earth lead to electrical circuits of pipes containing gases or flammable liquids.

Proper Grounding

Grounding of electrical circuits is a safety practice that is documented in various codes and standards. A typical arc welding setup may consist of several electrical circuits. Applying and maintaining proper grounding methods within the welding area is important to promote electrical safety in the workplace. Associated processes such as plasma cutting will also benefit from proper grounding.

Where welding machines that use a plug on the end of a power cord, the grounding conductor connection is made automatically when the welding machine is plugged into the receptacle. The grounding pin of the plug makes a connection within the receptacle.

- ⚠ **IMPORTANT! You must still earth your work piece / job.**
- ⚠ **WARNING! The use of adapters that effectively remove the grounding pin connection at the plug is not recommended.**
- ⚠ **WARNING! Do not cut off or remove the grounding pin from the plug. All safety benefit of the grounding conductor is lost without the connection.**

Grounding the Work Piece / Job

The welding circuit consists of all conductive material through which the welding current is intended to flow. Welding current flows through the welding machine terminals, welding cables, work piece / job connection, gun, torch, electrode holder and work piece / job itself; the welding circuit is not connected to ground within the welding machine, but is isolated from ground. How do we ground the welding circuit?

The work piece / job or the metal table that the work piece / job rests upon must be grounded. We must connect the work piece / job or work table to a suitable ground, such as a metal building frame. The ground connection should be independent or separate from the welding circuit connection.

Grounding the work piece / job has similar benefit to grounding the welding machine enclosure. When the work piece is grounded, it is at the same potential as other grounded objects in the area. In the event of insulation failure in the arc welding machine or other equipment, the voltage between the work piece and ground will be limited.

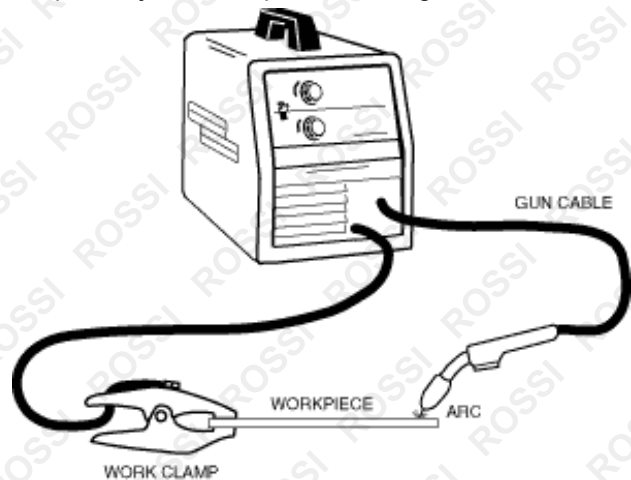

⚠ **WARNING! Welding Circuit Shock Hazards.**

Utilising proper grounding in the welding environment is a good practice, but it does not remove all possibility of electrical shock. The welding circuit is energised by welding voltage. A person will receive a shock if they become the electrical path across the welding circuit. Precautions must be taken to insulate the welder from the welding circuit. Use dry insulating gloves and other insulating means. Also maintain insulation on weld cables, electrode holders, guns and torches to provide protection.

Shielding Gas Safety

This article is intended to give users some basic information about the recommended safety procedures concerning the use of welding shielding gases. It does not cover the use of other gases such as oxygen or acetylene as those need much more careful transporting, storage and handling procedures than shielding gases.

Cylinder identification: Welding shielding gases are commonly one of three types - argon, argon and carbon dioxide mix, mixes of various compositions and carbon dioxide.

Cylinders are colour coded;

- Argon cylinders are green
- Argon/carbon dioxide mix cylinders are green with a light green shoulder
- Carbon dioxide cylinders are black with a silver/grey shoulder.

⚠ Some carbon dioxide cylinders contain a dip tube to extract the liquid from the cylinder. The tube runs down the centre of the cylinder and draws the liquid carbon dioxide up through the valve. These can be identified by the white stripe down the side - they are not suitable for use with regulators.

All the three basic types of shielding gases are heavier than air and are asphyxiants so should only be used in well-ventilated areas.

Industrial gas cylinders typically have to be tested every 10 years to ensure they are in good order with some having a test period of 5 years.

Transporting and Handling:

- The transporting of gas cylinders is covered by the Carriage of Dangerous Goods and Use of Transportable Pressure Receptacles Regulations.
- A 2KG fire extinguisher is required by law to be carried whenever you are transporting any type of gas cylinder.
- Cylinders come in several sizes and fill pressures with some being filled to 300 bar (4350 psi) so therefore they need careful handling, storage and use.
- Although not required for non-trade users, it is recommended to display a compressed gas warning diamond on your vehicle whenever you have a cylinder on board to help the emergency services evaluate any potential hazard in the event of an incident. Removing it when you don't have a cylinder on board will reduce the likelihood of being stopped by the authorities.

Basic cylinder safety advice:

- Only keep as much gas as you actually need. More cylinders = more risk
- Always wear appropriate hand and foot protection when moving or transporting cylinders.
- When transporting cylinders, always have an appropriate Material Safety Data Sheet (MSDS) available and be familiar with the properties of the particular gas you are transporting.
- Always secure cylinders while transporting and wherever possible, transport them upright and in an open vehicle.
- If transporting cylinders in an enclosed vehicle, always ensure you have adequate ventilation, i.e. an open window.
- If you suspect a cylinder has developed a leak during transport, park the vehicle in a safe place with the windows down and telephone the agent or the supplier for advice.
- If you are involved in a road accident, advise the emergency services that gas cylinders are being carried and show them any information relating to the cylinders, e.g. the Material Safety Data Sheet (MSDS)

- Remove the cylinder from the vehicle at the earliest opportunity, place in the proper storage area and secure it.
- Visually inspect the cylinder for damage to the body and the valve assembly, if there is any sign of damage, do not use it and inform your supplier immediately.
- Before using any gas cylinder, check that the seal is intact, also check for the proper labelling to ensure that the gas the correct one you asked for before you remove the seal.

Cylinder Use:

- Store cylinders in a well-protected, dry and well-ventilated area ensuring they do not block entry or exit routes and are protected from physical damage from striking or falling objects and from any potential tampering.
- Cylinders should also be stored out of direct sunlight.
- Use cylinders in the order in which they were received, i.e. first in - first out.
- Ensure the valve seat and regulator thread/seat are free from any foreign matter including dirt, oil or grease. Remove any foreign matter by wiping with a clean, dry cloth, by using compressed air or by briefly opening and closing the valve (known as "sniffing" or "cracking"). When using compressed air or 'sniffing', wear eye and ear protection and always ensure that you point the cylinder valve or air blowgun away from yourself and others.
- Fit the regulator then open the cylinder valve slowly at arm's length. Check for leaks using soapy water.
- Always store cylinders in an upright position and secure with a chain or strap above the centre of the body.
- If a cylinder key is required to open a cylinder, always leave it in place to make it easier to close the valve after use or in an emergency. Always use the correct key, they cost no more than a few dollars at most.
- Always close the cylinder valve after use.
- Always close the valve when the cylinder is empty to prevent air or moisture from entering the cylinder.

- ⚠ **Do not attempt to lift a large cylinder single-handed.**
- ⚠ **Do not roll a cylinder horizontally to move it.**
- ⚠ **Do not carry a cylinder by the valve.**
- ⚠ **Do not leave an open cylinder unattended.**
- ⚠ **Do not leave a cylinder unsecured.**
- ⚠ **Do not leave cylinders in hot cars.**
- ⚠ **Do not force incorrect fittings onto the wrong cylinder.**
- ⚠ **Do not disguise any damage to cylinders.**
- ⚠ **Do not attempt to refill a cylinder or decant gas from one cylinder to another. This is especially important with pub type CO2 cylinders; they can suffer from severe internal corrosion due to any beer or soft drinks in the gas line being forced into the old cylinder when a new cylinder is connected.**

- ⚠ **Do not attempt to mix gases in a cylinder.**
- ⚠ **Do not fill a cylinder with a gas different to the one it originally contained.**
- ⚠ **Do not remove or deface cylinder content identification labels.**
- ⚠ **Do not tamper with cylinders in any way.**
- ⚠ **Do not attempt to repair a cylinder.**
- ⚠ **Do not repaint cylinders in a different colour to the original.**
- ⚠ **Do not discard cylinders; return them to the correct agent or supplier.**
- ⚠ **Do not use grease, oil or Teflon tape on the regulator or valve thread/seat.**
- ⚠ **Do not use a co2 regulator on an argon or argon mix cylinder unless the regulator is specifically designed to handle the higher pressure.**

Disposal of used cylinders:

When you enter into a rental agreement, you are only purchasing the contents of the cylinder, not the cylinder itself which always remains the property of the supplier (not the agent). Empty cylinders should be returned to their respective suppliers. If the agent will not accept a returned cylinder, maybe due to age, missing labels, unknown contents, damage, etc., contact the supplier for assistance. If the supplier cannot help then it should be taken to a recycling centre for proper disposal.

General Safety

Repair or replace defective cables immediately.



Keep fire extinguishing equipment at a handy location near the job.



Never watch the arc except through filters of the correct shade.



Conduct engine exhaust to outside atmosphere.



In confined spaces, adequate ventilation and constant observation are essential.



Keep primary terminals and live parts effectively covered.



Leads and cables should be kept clear of passageways.



Never strike an electrode on any gas cylinder.



Never use oxygen for venting containers.



Parts Diagram

⚠ ATTENTION! Products covered by this manual will vary in appearance, assembly, inclusions, description and packaging.

A Typical Metal inert gas (MIG) / Flux-cored arc welding (FCAW) and Metal-cored Arc Welding (MCAW) setup

⚠ NOTE! The wire feed unit is shown separately for clarity. Most welders have wire feed units built into the welder.

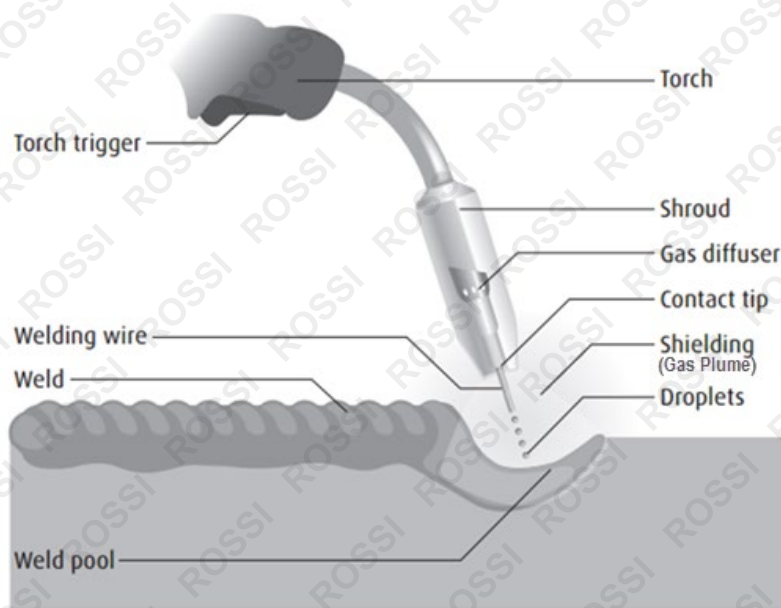
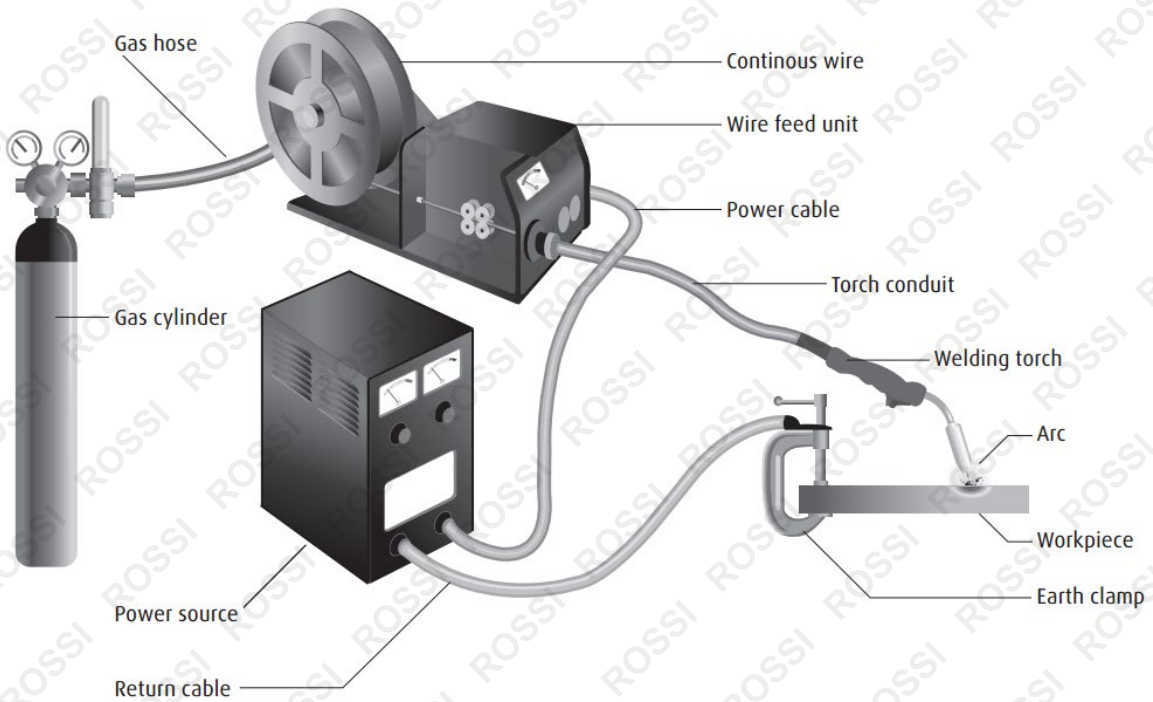

Typical MMA (Stick) Welding setup

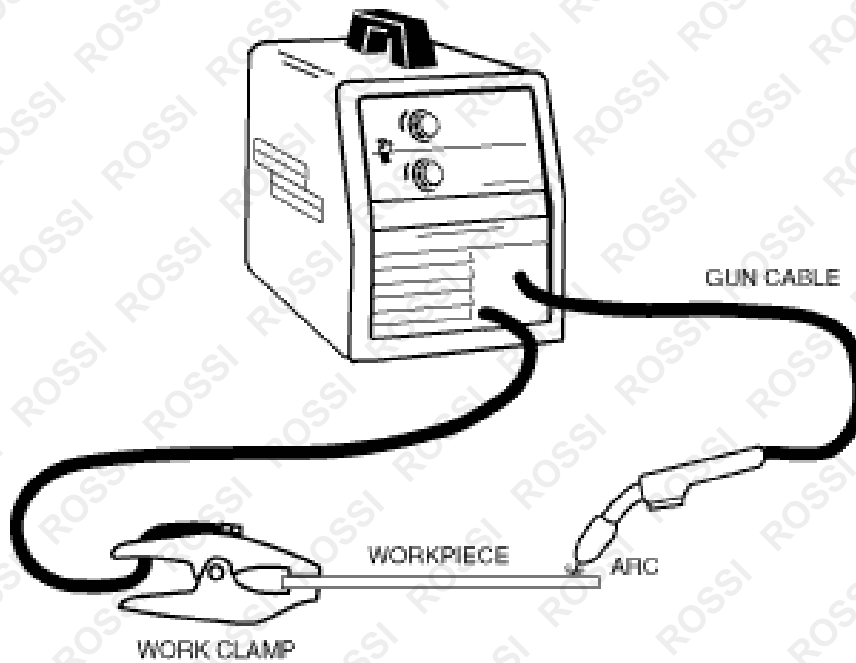

Typical TIG setup

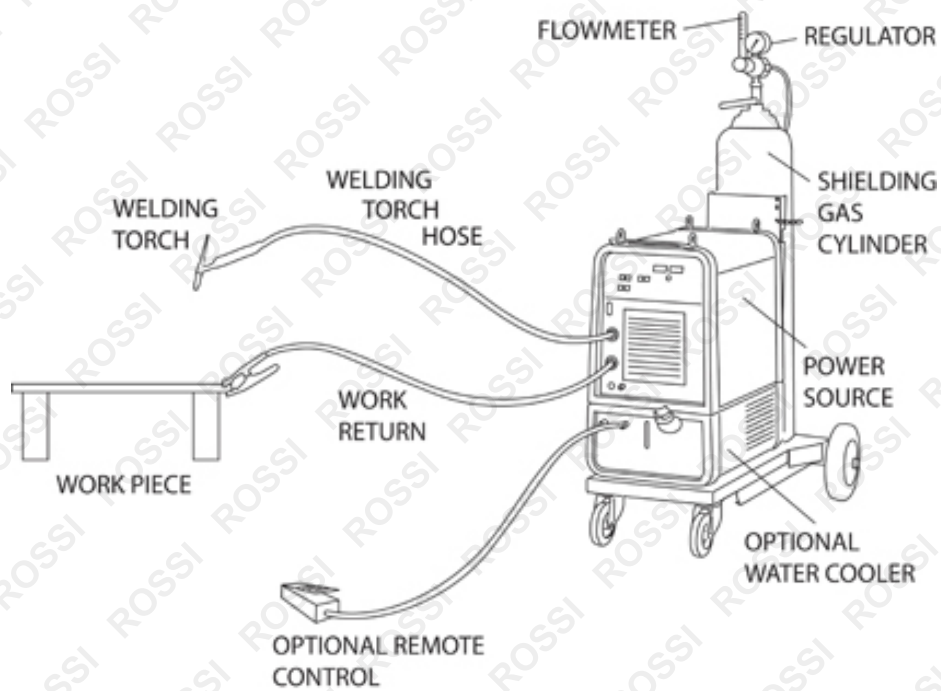

SUPER 200P AC/DC Welders

⚠ IMPORTANT! ARC Welding uses a negative ground (earth) connection. TIG / Plasma Cut use a positive ground (earth).

⚠ IMPORTANT! This welder is fitted with overheating protection. If the welder overheats it will go into protection mode and stop working with the O.C. indicator illuminated. If this happens do not turn off the machine; leave it on so the welder's internal fan can continue running and cool the machine down. Once the O.C. indicator light shuts off you can continue using your machine as normal.

⚠ ARC = Negative Earth

⚠ TIG = Positive Earth

⚠ PLASMA CUTTER = Positive Earth

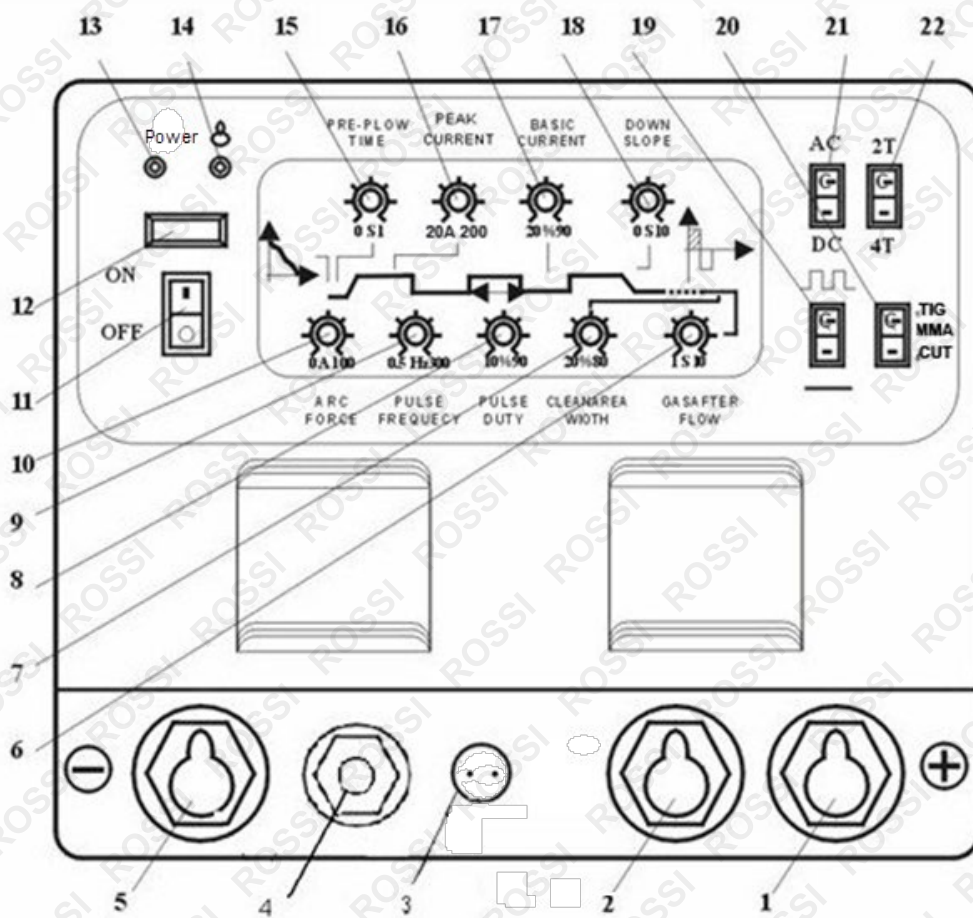

1. "TIG Earth" clamp connection & "ARC rod holder" connection.
2. "Plasma Earth" Clamp.
3. DIN Socket: High frequency start control.
4. "Plasma Torch" connection.
5. "TIG Torch" connection & "ARC earth" clamp connection.
6. **Post flow (Gas):** The length of time the torch gas flows after the arc terminates.
7. **Clean area width (Phase Balance):** Applies to AC welding and sets the proportion of time the weld current is positive, during which time the current has an "oxide penetrating" effect on the aluminium alloy weld pool surface, but which also tends to heat up and melt the tungsten electrode rather than the weld pool. Maximum heat is delivered to the work piece/job when the electrode is negative so this setting is used to achieve the best compromise when welding aluminium.
8. **Pulse Duty (duty cycle):** The number of minutes out of a 10-minute time period an arc welding machine can be operated at maximum rated output. An example would be 60% duty cycle at 300 amps. This would mean that at 300 amps the welding machine can be used for 6 minutes and then must be allowed to cool with the fan motor running for 4 minutes.
9. **Pulse Frequency:** The sequencing and controlling of the amount of current, frequency and duration of the welding arc.
10. **Arc Force:** This function enables operators to tailor the shape of the volt/amp curve to better suit the different joint configurations and electrode types.
11. **Main Power On/Off Switch.**
12. **Voltage display:** Welding voltage display when machine is working. Only shows information when welder is in use.
13. **Power indicator:** Displays if power supply is on or off.
14. **O/C:** Overheating alert indicator, this can also indicate power issues.
15. **Post Flow:** The length of time the torch gas flows before the arc starts.
16. **Peak current (pulse) –** Peak current is the nominal current for the high energy pulse. It is adjusted to a level that is set consistently above the globular to spray transition current. Peak current is expressed in units of ampere. During the time when the peak current is delivered, the molten droplet detaches from the electrode. An increase in peak current increases the average welding current and the weld penetration.
17. **Basic current (Amperage):** The amount of electricity flowing past a point in a conductor every second. Basic current is background current and is the low side of the pulse (1/2, 1/4 or even 1/10 of the peak current).
18. **Down-Slope Time:** Allows the current to decrease at whatever rate you set on the knob.
19. **Pulse/No Pulse switch:** For thin welding plate and up-welding etc. place the switch at PULSE position (for normal TIG welding set at no pulse).
20. **Welding Process Selection:** This button selects between MMA (ARC), TIG and CUT modes.
21. **AC/DC Selector Switch:** Select "AC" for Aluminium and Aluminium Alloys. Select "DC" for Stainless Steel, Steel, and Cast Iron etc.
22. **2T/4T Switch:**

2T: for using a switch on the torch handle...when you plug in the foot pedal or torch amperage control, most TIG inverters are designed to bypass the 2t and 4t settings because the amperage control overrides all the upslope and downslope. The 2t setting pretty much turns the torch switch into a 2 position switch. Press the switch, you get an arc, release the switch, arc goes out.

4T: The 4T position is most always used in conjunction with upslope and downslope settings.

For example;

 - a) *Press the button and you get an arc.*
 - b) *Release the button and set the arc up-slopes to whatever the main amperage is set to.*
 - c) *Press the button and arc down-slopes to lower amperage.*
 - d) *Release the button and arc stops.*
 - e) *Some machines are different but this is the general principle of 4t operation*

TC-205 AC/DC Welders

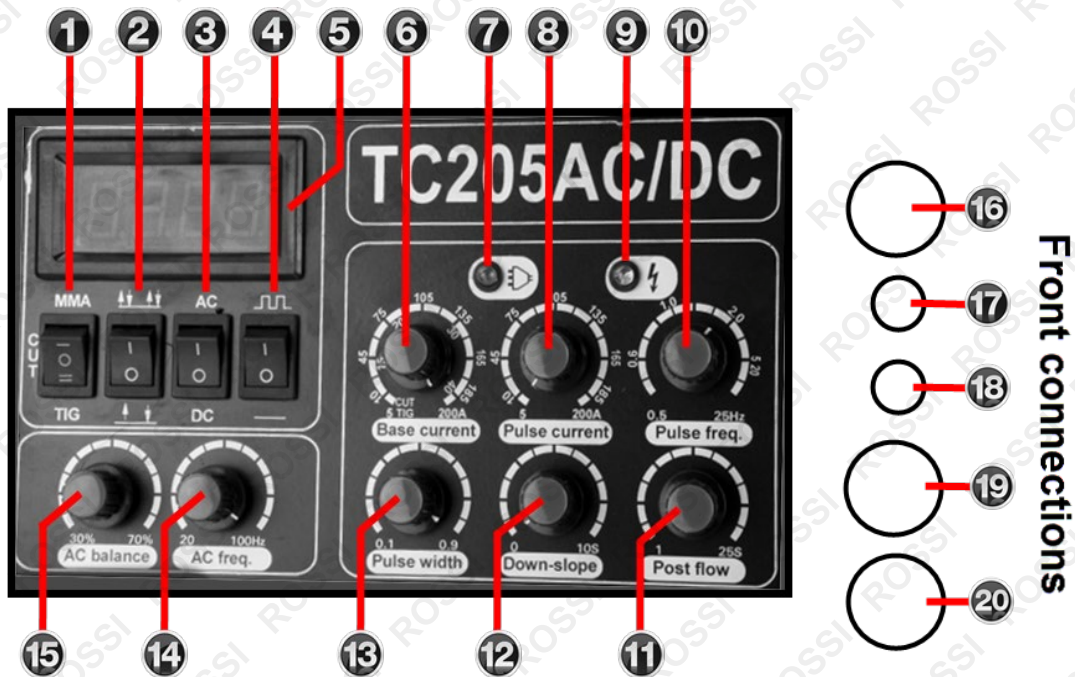

1. **Welding Process Selection:** This button selects between MMA/TIG and CUT modes.
2. **2T/4T Switch:**
 - 2T: for using a switch on the torch handle...when you plug in the foot pedal or torch amperage control, most TIG inverters are designed to bypass the 2t and 4t settings because the amperage control overrides all the upslope and downslope. The 2t setting pretty much turns the torch switch into a 2 position switch. Press the switch, you get an arc, release the switch, arc goes out.
 - 4T: The 4T position is most always used in conjunction with upslope and downslope settings.

For example;

 - a. Press the button and you get an arc.
 - b. Release the button and set the arc up-slopes to whatever the main amperage is set to.
 - c. Press the button and arc down-slopes to lower amperage.
 - d. Release the button and arc stops.
 - e. Some machines are different but this is the general principle of 4t operation
3. **AC/DC Selector Switch:** Select "AC" for Aluminium and Aluminium Alloys. Select "DC" for Stainless Steel, Steel, and Cast Iron etc.
4. **Pulse selector** switch; Selection of the Pulse mode switch provides pulsed welding current output.
5. **Voltage display:** Welding voltage display when machine is working.
6. **Base Current:** - Set the amount of electricity flowing past a point in a conductor every second.
7. **Power indicator:** Displays if power supply is on or off.
8. **Pulse Current:** is the nominal current for the high energy pulse. It is adjusted to a level that is set consistently above the globular to spray transition current. Peak current is expressed in units of ampere. During the time when the peak current is delivered, the molten droplet detaches from the electrode. An increase in peak current increases the average welding current and the weld penetration.
9. **O/C:** Overheating alert indicator, this can also indicate power issues.
10. **Pulse Frequency:** The sequencing and controlling of the amount of current, frequency and duration of the welding arc.
11. **Post Flow:** The length of time the torch gas flows after the arc terminates.
12. **Down-slope:** Allows the current to decrease at whatever rate you set on the knob.
13. **Pulse width:** The time the high pulse amperage stays on. Also known as Pule % on time.
14. **AC Frequency:** The A/C frequency knob allows you to weld with a much higher frequency. That option stiffens and focuses the TIG welding arc pinpoints the heat
15. **AC Balance:** This knob is used to balance DCEP (reverse polarity) and DCEN (straight polarity).
16. "TIG Earth" clamp connection & "ARC rod holder" connection.
17. **Remote control connection**
18. **Torch Control connector**
19. **Cut Torch Gas Outlet**
20. "TIG Torch" connection & "ARC earth" clamp connection.

MT 200 Welders

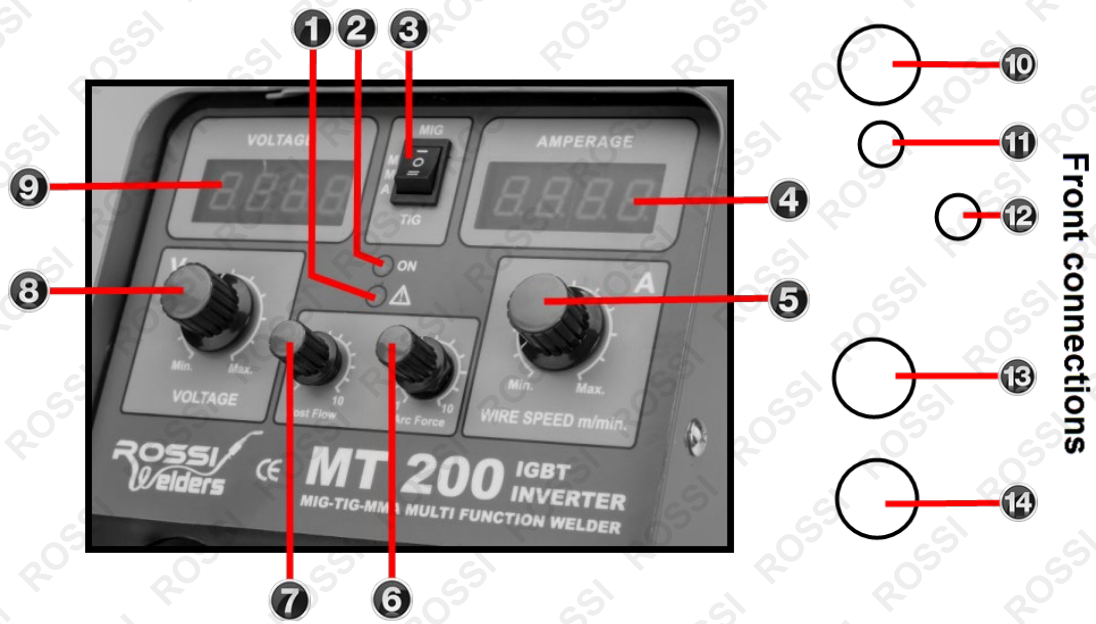

1. **O/C:** Overheating alert indicator, this can also indicate power issues.
2. **Power indicator:** Displays if power supply is on or off.
3. **Welding Process Selection:** This button selects between MMA/TIG and CUT modes.
4. **Amperage (current) display:** Welding Amperage display during welding.
5. **Wire Speed / Speed:** The speed at which wire is fed out of the machine.
6. **Arc Force:** This function enables operators to tailor the shape of the volt/amp curve to better suit the **different joint configurations and electrode types**. Higher settings make more dig and a "crisper" arc. Lower makes a smoother arc.
7. **Post flow (Gas):** The length of time the torch gas flows after the arc terminates.
8. **Voltage Adjustment.**
9. **Voltage display:** Welding voltage display when machine is working.
10. **Torch connection.**
11. **NA.**
12. **Wire feeder spool.**
13. Positive connection.
14. Negative (Earth) connection.

WELD-MIG185E Welders

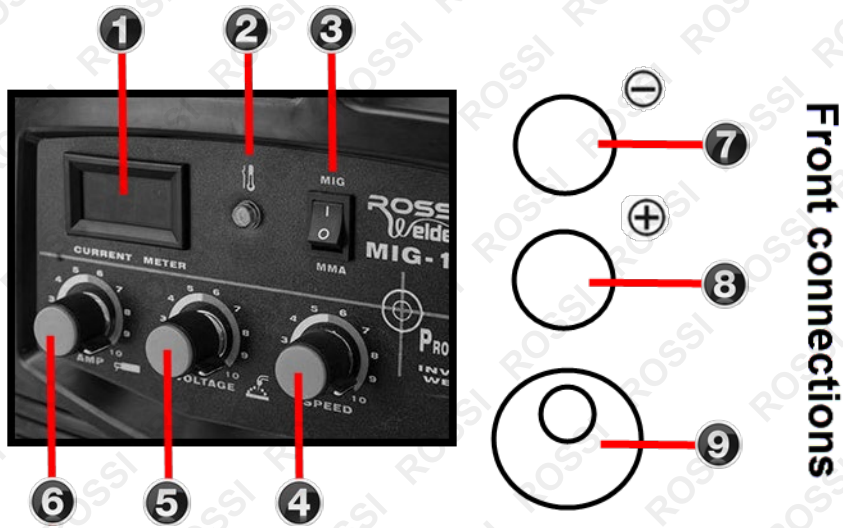

1. **Current (Amperage) display:** Welding Current display during welding.
2. **Overheating alert:** This indicator, this can also indicate power issues.
3. **Welding Process Selection:** This button selects between MMA and MIG.
4. **Wire Speed / Speed:** The speed at which wire is fed out of the machine.
5. **Voltage Adjustment**
6. **Amperage (current) Adjustment**
7. **Negative (Earth) connection.**
8. **Positive connection.**
9. **Torch connection.**

WELD-MIG220BZ Welders

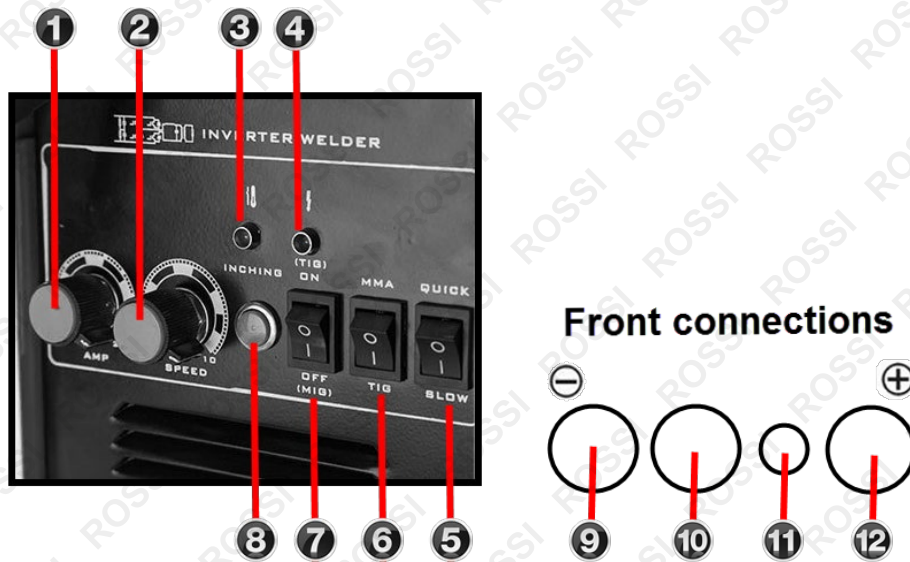

1. **Amperage (current) Adjustment**
2. **Wire Speed / Speed:** The speed at which wire is fed out of the machine.
3. **Overheating alert:** This indicator, this can also indicate power issues.
4. **Power indicator:** Displays if power supply is on or off.
5. **Inching Speed:** The speed at which wire is fed out when the
6. **Welding Process Selection:** This button selects between MMA and TIG.
7. **Welding Process Selection:** This button selects between TIG and MIG.
8. **Inching:** This button helps feed wire through the MIG and Torch instead of doing so by hand.
9. **Negative (Earth) connection.**
10. **Torch connection.**
11. **DIN High frequency out.**
12. **Positive connection.**

WLDMIG195RSSADJE, WLDMIG185RSSADJE & WLDMIG155RSSADJE Welders

1. **Overheating alert:** This indicator, this can also indicate power issues.
2. **Amperage selection:** Set amperage in conjunction with switch 3. 4 amperage levels available – MIN / 1 (low); MIN / 2 (medium-low); MAX / 1 (medium-high); MAX / 2 (high).
3. **Amperage selection:** Set amperage in conjunction with switch 2. 4 amperage levels available – MIN / 1 (low); MIN / 2 (medium-low); MAX / 1 (medium-high); MAX / 2 (high).
4. **Wire Speed / Speed:** The speed at which wire is fed out of the machine.
5. **Main Power On/Off Switch.**

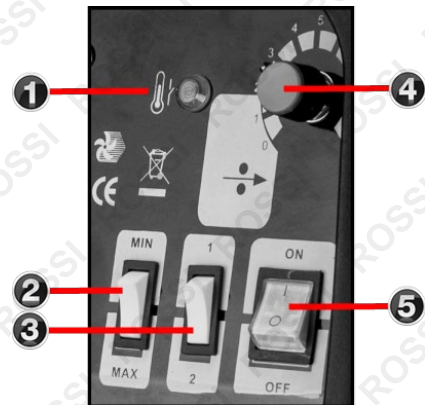

CT-520 Welders

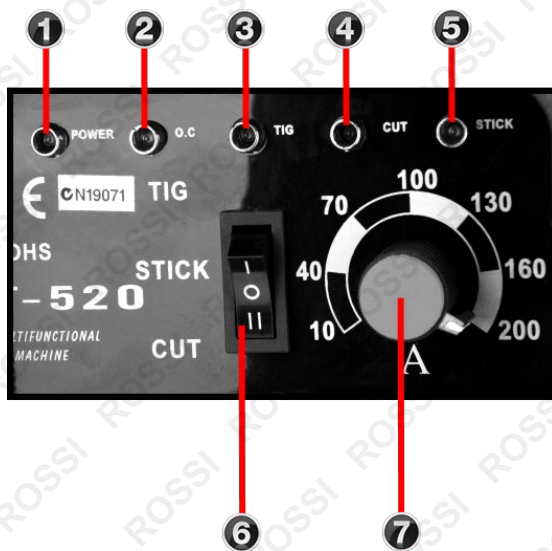

Front connections

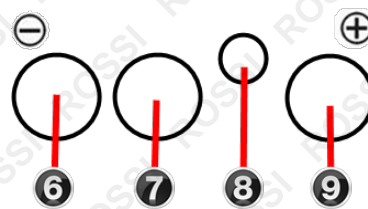

1. **Power indicator:** Displays if power supply is on or off.
2. **O/C:** Overheating alert indicator, this can also indicate power issues.
3. **TIG indicator:** Indicates when TIG mode is enabled.
4. **CUT indicator:** Indicates when CUT mode is enabled.
5. **STICK indicator:** Indicates when STICK (ARC) mode is enabled.
6. **Welding Process Selection:** This button selects between TIG, STICK and CUT.
7. **Amperage (current) Adjustment.**
8. **Negative (Earth) connection.**
9. **Torch connection.**
10. **DIN High frequency out.**
11. **Positive connection.**

ROSSWELDER WELDER-S200 Welders

1. **Amperage (current) Adjustment.**
2. **Power indicator:** Displays if power supply is on or off.
3. **O/C:** Overheating alert indicator, this can also indicate power issues.

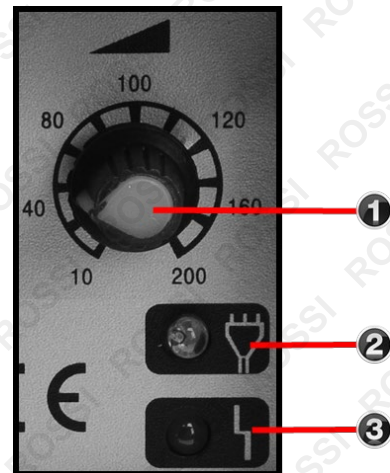

1. **Amperage (current) Adjustment.**
2. **Power indicator:** Displays if power supply is on or off.
3. **O/C:** Overheating alert indicator, this can also indicate power issues.
4. **Amperage display:** Welding Current display during welding.



MIG-130 Welders

1. **Overheating alert:** This indicator, this can also indicate power issues.
2. **Amperage selection:** Set amperage in conjunction with switch 3. 4 amperage levels available – MIN / 1 (low); MIN / 2 (medium-low); MAX / 1 (medium-high); MAX / 2 (high).
3. **Amperage selection:** Set amperage in conjunction with switch 2. 4 amperage levels available – MIN / 1 (low); MIN / 2 (medium-low); MAX / 1 (medium-high); MAX / 2 (high).
4. **Wire Speed / Speed:** The speed at which wire is fed out of the machine.
5. **Main Power On/Off Switch**



Which welder do I need?

Unfortunately, there is no single welding process suitable for all applications, so let's begin with an overview of the basic processes and highlight the capabilities and advantages of each. This will help us better match a process to your specific needs. If you have previous welding experience, feel free to skip ahead. If you are somewhat of a novice, this section will provide you with a better understanding of the types of welders available, how each performs and degree of welding skill required to operate each. In addition, we'll offer examples of specific applications best suited to each process.

Types of Welding

The most common welding processes include Stick, MIG/Flux-cored and TIG. Each process has its own unique set of benefits and limitations, works well in some welding applications, and not well in others.

ARC / Stick Welding



Arc welding is the process of using electrodes to fuse two pieces of metal.

- *Better suited for windy, outdoor conditions*
- *More forgiving when welding on dirty or rusty metal*
- *Works well on thicker materials*

If you learned to weld years ago, you likely learned using an arc welder. Stick welding has, for many years, been the most popular method for most home-shop welding needs. Stick welding uses an electric

current flowing from a gap between the metal and the welding stick, also known as an arc-welding electrode. Stick welding is an effective method for welding most alloys or joints and can be used both indoors and outdoors, or in windy areas. It is also the most economical welding method and largely popular because of its ability to create an effective bond on rusty or dirty metals.

Arc welding is limited, however, to metals no thinner than 18-gauge, requires frequent rod changing, emits significant spatter; and welds must be cleaned upon completion. Stick welding is also more difficult to learn and use, particularly the ability to strike and maintain an arc. Arc welders are available in either AC or DC or AC/DC; with AC being the most economical. It is used for welding thicker metals of 1/16-inch or greater.

MIG Welding / Gas Metal Arc Welding (GMAW)



MIG Welding is the process of using welding wire either with or without shielding gas to fuse two pieces of metal.

- *Easiest process to learn*
- *High welding speeds possible*
- *Better control on thinner metals*
- *Cleaner welds possible with no slag to clean*
- *Same equipment can be used for Flux-Cored Welding*

MIG welders use a wire welding electrode on a spool that is fed automatically at a constant pre-selected speed. The arc, created by an electrical current between the base metal and the wire, melts the wire and joins it together with the base, producing a high-strength weld with great appearance and little need for cleaning. MIG welding is clean, easy and can be used on either thin or thicker plate metals.

A slight variation of MIG welding — Flux-Cored Arc Welding (FCAW) — is similar in that it is also a wire-feed process but differs in that it does not require a shielding gas. This gas-free welding application uses Flux-Cored wire to shield the arc, and is a simple, efficient and effective welding approach, especially when welding outdoors, in windy conditions or on dirty materials. The process is widely used in construction because of its high welding speed and portability.

Both MIG and Flux-Cored are very easy to learn and can create extremely clean welds on steel, aluminium and stainless. Both types have the capability to weld materials as thin as 26-gauge.

TIG Welding / Gas Tungsten Arc Welding (GTAW)



TIG Welding is the process of using a tungsten-electrode and inert gas to fuse two pieces of metal

- *Provides highest quality, precise welds*
- *Highly aesthetic weld beads*
- *Allows adjustment of heat input while welding by use of a foot control.*

TIG welding is an arc welding process that uses a non-consumable tungsten electrode to produce the weld. The weld area is protected from atmospheric contamination by a shielding gas (usually argon), and a filler metal, though some welds, known as autogenous welds, do not require it. A constant-current welding power supply produces energy that is conducted across the arc through a column of highly ionized gas and metal vapours known as plasma.

TIG welding is most commonly used to weld thin sections of alloy steel, stainless steel and non-ferrous metals such as aluminium, magnesium, and copper alloys. The process grants the operator greater control over the weld than other welding processes, allowing for stronger, higher quality welds. TIG welding is comparatively more complex and difficult to master than other welding types, and is significantly slower.

The chart below identifies which weld process you can use for each type of metal. Keep in mind that many of these materials are also processed using varying combinations of two or more metals, a process that is helpful to reinforce strength and functionality.

Metal	Weld Process		
	MIG	Stick	TIG
Steel	•	•	•
Stainless Steel	•	•	•
Aluminium Alloys	•		•
Cast Iron		•	
Chromoloy			•
Copper			•
Brass			•
Exotic metals (Magnesium, Titanium, etc.)			•

Pulsed TIG Welding

Pulsed TIG Welding Reduces Heat Input and Warping on Stainless Steel for example stainless steel exhausts.

- Pulsed TIG lowers heat input; increases precision and quality.
- High-speed pulsing constricts and focuses the arc, which increases arc stability, penetration and travel speed, while producing a smaller heat affected zone.
- Lower heat input minimises distortion and improves weld quality.

TIG Welding at Warp Speed—Without the Warping!

Every TIG welding machine is slightly different but the concepts are basically the same. There are 4 basic settings to understand:

Pulsed TIG welding requires setting four variables: Peak amperage, Background amperage, Peak time and Pulse rate. Determining good values for setting peak amperage works much the same as setting maximum amperage values for regular DC TIG: use 1 amp for every .001 in. of thickness.

The peak time is simply the percentage of time during one pulsing cycle the power source spends at the peak amperage (main amperage). With peak time of 80 percent and a **pulse rate** of 1 pulse per second (PPS), the inverter will spend 8/10ths of a second at **peak amperage** and 2/10ths of a second at the background amperage. Increasing the peak time percentage adds more heat to the part, while decreasing peak time percentage reduces heat. As general rule of thumb, begin experimenting at 50 to 60 percent peak time.

The background amperage will be a percentage of the main amperage set on the machine. Thus, a machine set for an output of 150 amps and background amperage of 30 percent produces a background amperage output of 45 amps. Lowering the background amp percentage reduces the average heat input, while increasing the background amp percentage raises the overall amperage.

Especially notice how background current adjustments affect weld puddle fluidity. As a rule, use enough background current to shrink the puddle to about half its normal size while still keeping the puddle fluid. When welding stainless and carbon steels, start by setting the background amperage at 20 to 30 percent of peak amperage.

Pulse frequency per second (PPS) is simply how many times the machine will complete one pulsing cycle in a time span of one second. Increasing the number of pulses per second produces a smoother

the ripple effect in the weld bead, narrows the weld bead and adds more “cooling effect.” Reducing the number of pulses per second widens the weld bead. Slower pulsing also helps agitate the puddle and release any porosity or gas trapped in the weld (this is very helpful when welding aluminium with AC pulsed TIG).

Plasma Cutting



Plasma cutting is the use of high velocity jet of ionised gas to cut through metal.

- *Much faster than mechanical cutting*
- *Neater and more versatile than Oxy cutting*
- *Can cut a thickness up to 25mm (1")*
- *Can cut through a larger range of material than Oxy cutting*

Plasma cutting is a process that uses a high velocity jet of ionized gas that is delivered from a constricting orifice. The high velocity ionized gas, that is, the plasma, conducts electricity from the torch of the plasma cutter to the work piece. The plasma heats the metal, melting the material. The high velocity stream of ionized gas mechanically blows the molten metal away, severing the material.

Plasma cutting is ideal for cutting steel and non-ferrous material less than 1 inch thick. Oxy cutting requires that the operator carefully control the cutting speed so as to maintain the oxidizing process. Plasma is more forgiving in this regard. Plasma cutting really shines in some niche applications, such as cutting expanded metal, something that is nearly impossible with oxy. And, compared to mechanical means of cutting, plasma cutting is typically much faster, and can easily make non-linear cuts.

Getting Started

⚠ **IMPORTANT!** The actual Earth can vary from positive to negative depending on the type of function / machine you are using! Be sure to check you have configured your welder with the correct earthing terminal before starting your project.

⚠ **TIG Welders generally use a positive earth** – please check and understand your equipment before use.

TIG welding Basics

Tungsten - For welding steel the tungsten should be ground to a long point with the taper length about 2 or 3 times the diameter of the tungsten. The long taper and sharp tip improves arc stability. For a butt weld or open corner weld the stick out would be about 5-6mm.

Gas Shrouds - For general purpose work on steel a number 7 shroud is a good compromise. A smaller number 4 shroud would be more suitable for fillet welds, and larger shrouds might be used for aluminium, the larger the shroud the better the gas coverage.

Shielding Gas - Pure Argon is normally used as a TIG shielding gas and is suitable for both steel and aluminium welding. The shielding gas must be completely inert - MIG shielding gasses cannot be used as the CO2 would cause the tungsten to oxidise.

Flow Rate - Flow rate will generally be 6 to 7L/min. The rate might be increased slightly to compensate for windy conditions. TIG uses a lot of shielding gas so it pays to set up the gas flow accurately. A flow meter attached to the regulator will give a more accurate flow reading than the gauge on the regulator, or a peashooter type flow meter can be used to measure flow at the torch.

Post-Flow Time - Post flow protects the tungsten and the weld as they cool. The tungsten will take longer to cool from higher amps, and a rough rule of thumb is to increase post flow time by 1 second for every 10 amps. Most basic work uses a post flow of 4-5 seconds.

Polarity - DC TIG Welding is carried out with the torch negative and the work positive. That is also known as DCEN (DC electrode negative) or "straight" polarity for those with older welders. About two thirds of the heat goes to the positive side or the arc. For TIG the negative torch helps avoid overheating the tungsten.

ARC Welding Basics

Arc welding (short for Manual Metal Arc (MMA) welding and also known as Stick and SMAW) is a very involved subject and this below information is only a basic introduction.

Arc Welding Safety - As with any other electric welding process, skin and eyes need to be properly protected from UV light. Electric shock, fumes, burns, and fire are other risks.

The safety page discusses how to minimise these risks.

Starting the Arc - The arc is started by touching the electrode momentarily against the work to complete the electrical circuit before raising the electrode to establish the arc.

'Tap starting' and 'scratch starting' are the two common methods of starting the arc. Which one to use is a personal preference, and can be influenced by rod and welder type.

Rod Position, Arc Length and Movement - Arc welding takes some effort to learn, and it is very sensitive to the position of the work.

Rod Angle – For welding on the flat work piece the rod should be angled 10 to 20 degrees from vertical and pulled in the direction of the arrow. The angle of the rod prevents the slag overtaking the rod (welding over slag would cause inclusions in the weld). It's OK to support the top of the electrode with your spare hand and this improves control of the electrode. Electric shocks aren't a problem, but be careful to reposition your hand away from the heat before the electrode gets too short.

Arc Length – The arc length is the distance between the electrode and the weld pool. It should be roughly the same as the diameter of the rod. This is nowhere near as straightforward as it sounds. The weld pool will also be hidden by molten slag. To achieve the correct arc length using 3.2mm rods the distance between the flux coating on the rod and the flux on top of the weld might be less than 1mm.



Arc welding faults - When learning any new process you'll likely start off doing things wrong. Typically the faults encountered are caused by the following:

- Incorrect travel speed
- Incorrect arc length
- Incorrect amps.

Flat Joints and Joint Preparation - Arc welding is especially suitable for joining thick material as cold joints are easy to avoid. That makes it possible to tackle thicker material using multiple passes of weld.

Fillet Joints – Fillet Joints are beyond the scope of this manual.

Installing MIG wire

⚠ IMPORTANT! MIG welders are very sensitive to wire feeder settings and liner condition. The wire liner is a service item and should be replaced regularly especially if rusty wire has been run through it.

MIG WIRE FEEDER

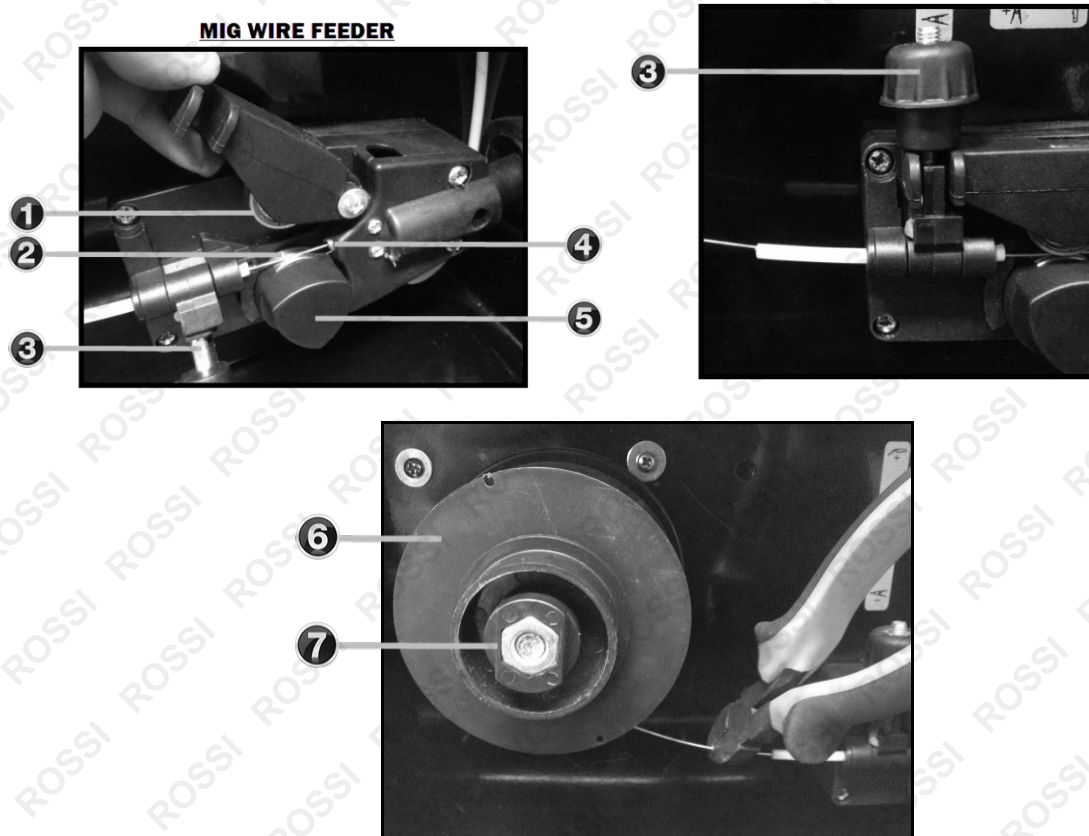

1. Wire Feed Tensioner
2. Wire roller (change to suit wire diameter)
3. Feed tensioner adjuster knob.
4. Wire Sleeve
5. Wire roller locking cap
6. Wire Spool
7. Wire spool spring tensioner

Preparing the wire - The wire reel mounting normally includes a spring tensioner. This tensioner should be initially tightened to the point where the reel of wire doesn't unravel under its own spring tension.

The first 3 inches of wire should be as straight as possible to reduce the chance of damage to the liner or snagging as the wire is fed through. Sharp wire cutters can be used for trimming.

Letting go of the end of the wire would cause it to unravel and tangle.

Feeding the wire to the torch - The wire is inserted through the guide tube and over the roller. On the torch side of the welder the small hole of the end of the wire liner should be visible. The end of the wire can be aligned with that hole using a small screwdriver or the piece of wire that was removed at the start.

The wire can then be pushed into the liner manually for a few inches, and should feed easily and without any force. If force is required it is likely that the wire has missed the liner.

The wire feed roller itself will normally have two grooves, and is secured either by a grub screw in the side of the roller, or a knurled plastic cap as in the photo. The grooves on welders are normally matched to 0.6mm, 0.8mm and 1mm wire and the roller can be reversed / swapped to line up the appropriate groove for the wire size being used.

Rust or grease on the wire can reduce the effectiveness of the rollers, and they need to be cleaned with a dry cloth before inserting the wire.

With the wire pushed a couple of inches into the liner replace the tensioner clamp, switch on the welder and use the wire feed mechanism to push the wire through the liner. The torch should be as straight as possible especially near the torch to reduce the chance of the end of the wire catching inside the liner.

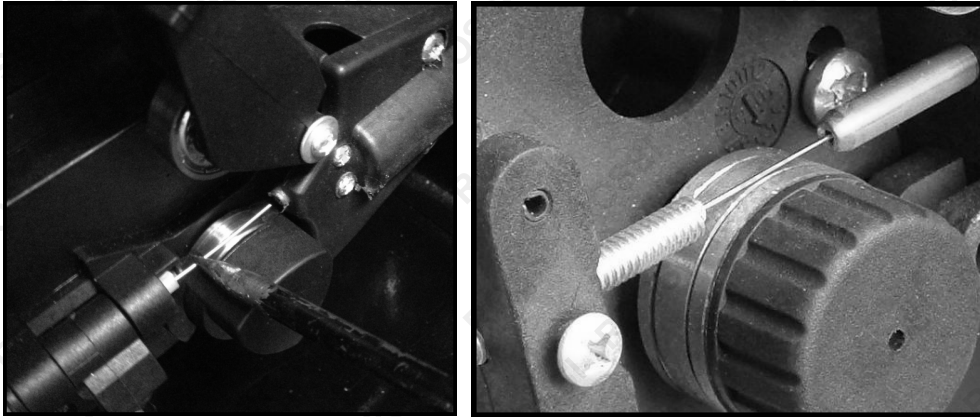

On some welders it can help to remove the contact tip from the end of the torch before feeding the wire through. The gas shroud is secured by a spring and can be removed by pulling and twisting in a clockwise direction, and the tip has a standard screw thread that unscrews in an anti-clockwise direction. Never unscrew the tip when it is still hot or it may break or strip the thread inside the torch.

If the wire snags in the torch it may be possible to withdraw a little wire onto the reel, and use a rotating motion with the torch to get the wire past the snagging point.

Setting the roller tensioner - The wire is driven by friction between the wire feed drive roller and the wire. Care in tensioning the wire feed can prolong the life of the tensioner mechanism.

Tightening the tensioner fully can cause the tensioners or tensioner mountings to bend and could also shear the motor gear if the wire were to stick in the tip during welding. The minimum tension that will ensure good wire feed is recommended.

One way to judge the wire feed tension is to grip the wire very lightly between your fingers and pull the trigger. Care is needed with this approach as if the wire were to touch the earth clamp it would arc, resulting in burned fingers and possibly arc eye.

Starting with very little tension on the wire feed mechanism, increase the tension until the wire feed stops slipping, but do not grip the wire so tightly that the wire feed motor slows.

The wire should ideally start to slip inside the rollers before the motor stalls.

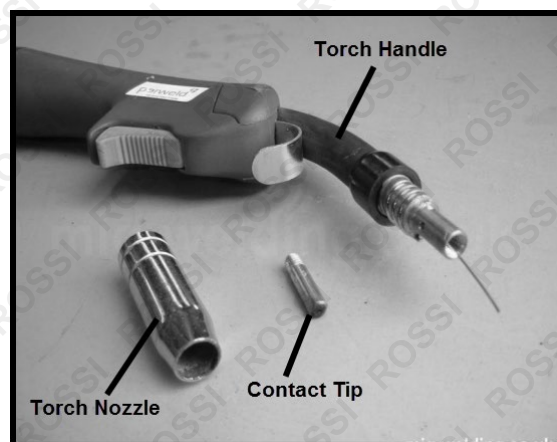

Setting the reel tensioner - Finally check the tension on the wire reel. The tensioner on the reel is there to stop the wire becoming loose and tangled, but the tension should be as light as possible to make life easy for the wire feed mechanism.

Set your wire speed to the maximum you are likely to use, and press the trigger on the torch. The wire reel should stop without unravelling when you lift off the trigger.

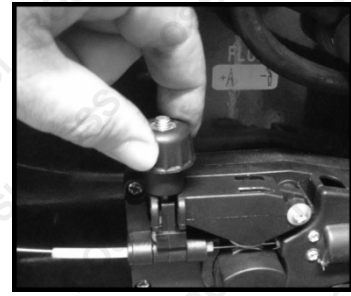

Avoiding wire feed problems - Wire feed problems are commonly caused by rusty welding wire. The rust acts as a lubricant on the feed rollers causing slip, and as an abrasive on the wire liner which increases resistance.

Wire can quickly go rusty when left unused inside a welder. Ideally the wire should be removed and stored indoors when the welder is not in use. This wire in the photo was reusable after the top couple of layers of wire had been removed. Liners damaged by rusty wire can be replaced fairly cheaply.

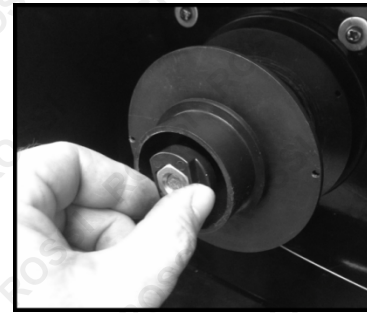

Other wire feed info - Wire liners do wear and are considered to be a service item. Professional welders might replace the liner after every 100kg of wire. On most welders the liner can be unscrewed at each end and pulled out of the cord.

Click here for a brief video showing how to change the spool on a typical MIG welder.



Troubleshooting

Power source

Component	Fault symptom	Cause
Primary cable	No or low welding output	Bad or incorrect primary connection, lost phase
Earth cable and clamp	Arc will not initiate	Damaged, loose or undersized cables and clamps
Connectors and lugs	Overheating of connectors and lugs	Loose or badly crimped connectors
Switches	Erratic or no output control	Switches damaged or incorrectly set for the application

Wire feeder

Component	Fault symptom	Cause
Gas solenoid valve	No gas flow or gas flows continuously	Gas valve faulty or sticking in open position
Wire feed rolls	Wire slippage, wire deformation	Incorrect feed roll size, incorrect tension adjustment, misalignment
Inlet, outlet guides	Wire shaving or snarling	Incorrect wire guide sizes, misalignment
Universal adaptor	Wire restriction, gas leaks, no trigger control	Universal adaptor not correctly mounted or secured, incorrect size of internal guide, bent contact pins
Wire feed speed control	No control over wire feed speed, no amperage control	Faulty wire speed feed potentiometer, wire feed motor in overload or trip condition
Wire inch switch	Wire live when feeding through cable and torch before welding	Faulty wire inch switch, inappropriate use of torch trigger switch
Spindle	Wire spool drags or overruns	Spindle brake set too tight or too loose, spool not properly located on spindle

Welding torch

Component	Fault symptom	Cause
Type	Welding torch overheats	Welding torch underrated for welding application
Liners	Erratic wire feed, wire snarls up at outlet guide	Liner of incorrect type and size for wire in use, worn or dirty liner, liner too long or too short
Gas distributor	Inadequate gas flow, contaminated or porous weld	Damaged or blocked distributor
Nozzle	Inadequate gas cover, restricted joint accessibility	Nozzle too large or too small, incorrect length or shape
Contact tip	Erratic feeding, wire shudder, wire burnback, unstable arc, spatter	Incorrect size of contact tip, incorrect contact tip to nozzle distance for metal transfer mode, inferior contact tip material
Nozzle insulator	Arcing between contact tip and nozzle and between nozzle and workpiece	No nozzle insulator fitted

Regulator / flowmeter

Component	Fault symptom	Cause
Inlet stem	No gas flow, gas leaks at regulator body or cylinder valve	Blocked inlet stem, leaking inlet stem to body thread, bullnose not properly seated in cylinder case
Gas hose and fitting	Leaks at connections or in the hose, porosity in the weld	Poorly fitted 'o' clips, damaged hose, air drawn into gas stream

Shielding gas

Component	Fault symptom	Cause
Cylinder, MCPs	No gas flow, porosity in the weld	Gas cylinder closed or empty, faulty cylinder valves
Bulk	No gas flow, change in welding conditions	Bulk tank empty, incorrectly set mixing panel

Welding wire

Component	Fault symptom	Cause
Wire basket and spool	Erratic wire feeding or wire stoppages	Damaged wire basket, loose spooling, random-wound wire
Wire	Wire sticks in contact tip, erratic feeding	Varying wire diameter, copper flaking, surface damage
Wire	Weld has excessive amount of spatter	Wrong polarity has been selected

Arc Welding Faults

Arc Length Too Short

This weld was laid with the end of the rod covered by the molten slag. The surface of the weld is uneven where it has been dragged along by the rod, and the weld will be low on power and contain slag inclusions.

Arc Length is OK.

This is a normal arc weld. The weld has a consistent profile and minimal spatter.

Arc Length Too Long

Too great a distance between the rod and the work will increase the voltage resulting in a flat and wide weld with a great deal of spatter. It also makes the arc unstable, and the slag will be difficult to remove from the edges of the weld. Sectioning this weld reveals undercutting to the left side.

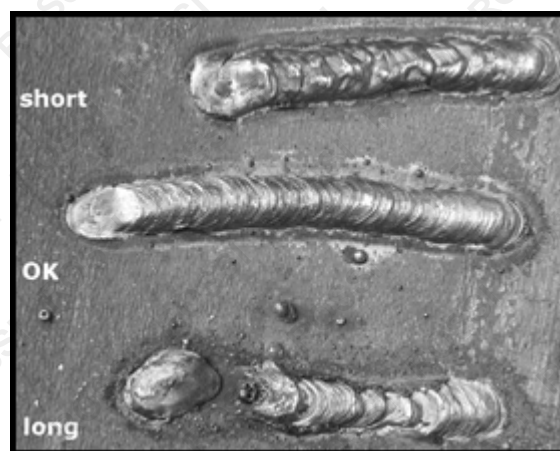

Travel Speed Faults

Speed is OK. - The bead is fairly consistent. The ridges in the weld are semi-circular.

Speed Too Fast - Excessive speed results in a thin, weak bead. The ridges in the weld are elongated and triangular. Had the current been increased to compensate for the speed the ridges would still remain elongated.

Speed Too Slow - Welding too slowly results in a wide tall build-up of weld. The shape of the weld is not consistent as the weld pool has built up and then collapsed into the crater. The poor control of the weld pool can result in cold joints and slag inclusions.

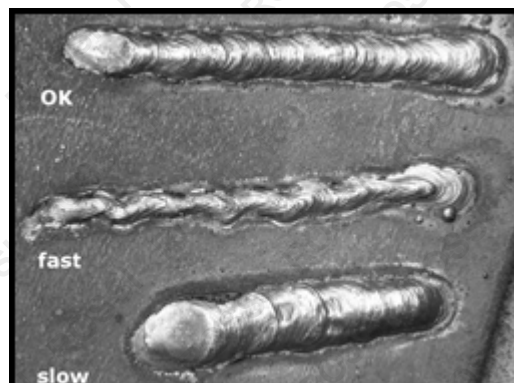

Current Setting Faults

Amps too low - Setting the amps too low will result in a tall, narrow bead lacking in penetration. The weld will be difficult to start and the arc prone to straying towards one side of a joint in preference to the other.

Amps too high - The bead is wide, flat and irregular, and a small undercut can be seen on the right of the weld in the sectioned photo. A deep crater has formed at the end of the weld, and the slag is difficult to remove from the edges of the weld.

Excessive current should not be compensated by excessive travel speed. This can result in slag inclusions due to rapid cooling of the weld.

Amps are OK. - With the amps set correctly the bead is a consistent rounded shape, and the slag is easy to remove.

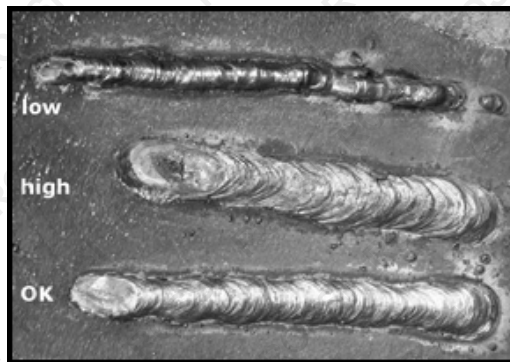

TIG Welding Faults

Poor Gas Coverage Leads to Contamination - The shielding gas is not turned on, there is either too little or too much gas shielding, or the gas shielding is blown away.

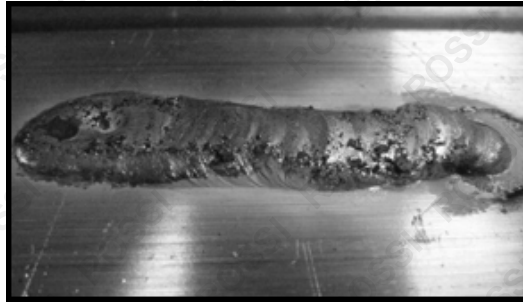

Check the gas cylinder label to be sure you're using the right type of gas for TIG welding, generally 100 percent argon (or perhaps an argon/helium blend for thick aluminium). Attempting to weld with an AR/CO₂ mix (used for MIG welding) will cause immediate contamination.

Set the proper gas flow rate, which should be 15 to 20 cubic feet per hour (cfh). Welders commonly—and incorrectly—assume that a higher gas flow/pressure provides greater protection. In fact, excessive gas flow creates turbulence and swirling currents that pull in unwanted airborne contaminants (and it can cause arc wandering).

Check all the fittings and hoses for leaks. Any breach may pull air into the shielding gas stream, which can cause the weld to be contaminated (and you'll waste money if gas escapes). Rub soapy water over the hose and all fittings. If bubbles form, you have a leak and need to replace the defective components. **You may have a tank contaminated with moisture.** Check with your gas supplier to resolve this issue.

MIG Welding Faults

No Shielding Gas on Steel - A lack of or inadequate shielding gas is easily identified by the porosity and (pinholes) in the face and interior of the weld.

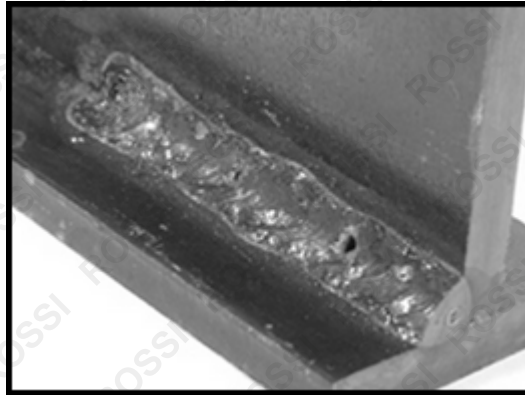

On aluminium, a sooty looking weld can be caused by using a drag vs. a push technique. The soot can be removed, but cutting the weld open will reveal pinholes where impurities are trapped in the weld. Aluminium builds up an oxide that needs to be removed before welding. Wire brushing is the most common method of cleaning aluminium, but it needs to be done with a stainless steel brush to avoid contaminating the weld with the impurities of a steel brush. Push vs. drag technique. On steel, either pushing or dragging the gun is acceptable, but with aluminium, the drag technique will lead to weld defects.

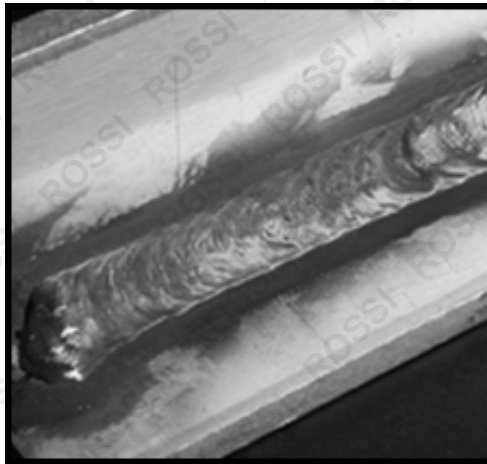

Lack of Fusion: Lack of fusion can occur when the voltage or wire feed speed is set too low, or when the operator's travel speed is too fast. Because aluminium conducts heat much faster than steel, it is prone to lack of fusion at the start of a weld until enough energy is put into the weld. Some welding equipment addresses this by automatically ramping up the current at the start of a weld and then decreasing it to avoid too much heat build-up.

Craters: With aluminium, craters can form at the end of a weld. If they are not filled in, they create a stress point, which can lead to cracking. This requires the user to quickly trigger the gun again to fill in the crater, although some welding machines offer a crater timer that will fill in the crater when the gun trigger is released.

Burn Through: Too much heat input can be caused by setting voltage or wire feed speed too high or by too slow of a travel speed. This can lead to warping or burn through especially on the thinner materials found in the sign industry, aluminium being more prone to the effects than steel. Generally aluminium requires a faster travel speed than steel to avoid heat build-up.

Feeding aluminium: Because of its low columnar strength, feeding aluminium wire has been likened to pushing a wet noodle through a straw. Bird-nesting or the tangling of the wire between the drive roll and the liner is a common, time-consuming and costly problem. Clearing it requires the operator to stop welding, cut the wire, discard the wire in the gun, and re-feed new wire through the liner. It also may require cleaning or changing the contact tip because of the burn back caused when the wire stops feeding. There are several ways to feed aluminium wire: Push only, spool gun, push-pull system and continuous feed push only system.

Push only: Feeding aluminium wire through a push only system can be difficult, but it can be done on a limited basis. It requires u-groove drive rolls to provide more surface contact with the wire, a Teflon liner, adequate drive-roll pressure, the ability to keep the gun cable straight and a high tolerance for pain.

Spool Gun: A spool gun eliminates the possibility of bird-nesting by putting a 10 cm (2.5kg.) spool on the gun, so the wire only feeds a few inches. Spool guns can accommodate aluminium wire diameters from .06 to .08mm and allow the operator to use longer cables (4.5 m-15 m).

A spool gun needs to have the roll changed after every pound of wire is used, compared with the 3.5- or 7 kg spool on a push-pull system.

Push-pull gun: With a push-pull gun, a motor in the gun pulls the wire through the liner, while the motor in the welder or feeder control becomes an assist motor. By maintaining consistent tension on the wire, the push-pull system helps eliminate bird-nesting. It is more ergonomic than the spool gun, since the weight of the spool is not in the operator's hands.

Also, the spool needs to be changed less often than on a spool gun and allows the purchase of larger spools. However, remember that aluminium builds up an oxide layer after being exposed to air for a while. If you only go through a pound or two of aluminium a week, the smaller spool may be a better choice.

Plasma Cutting Faults

Instances where the metal was not fully cut indicate a few different problems. If the ground clamp was not properly attached to the material this can happen. A similar cut can happen if there was a drop in air pressure, moisture in the air line, or a drop in power. A third cause is if the torch contacts the material, most plasma cutters will go into a low power mode when this happens causing the cut not to penetrate all the way.

Specifications

WLDMIG195RSSACAA



Process: MIG / MAG / MMA
Input power: 240V, 50Hz
Rated output (duty cycle): 195A-10%, 74A-60%, 60A-100%
Welding amperage range: 40-195Amps (Max)
No load voltage: 33V
Single pass weld: -
Weldable metals: -
Wire diameter range: -
Max spool size: 5kg
Other Specifications: Refer to brochure or advertisement

CT-520



Process: TIG / MMA / CUT
Input power: 240V, 50Hz
Rated output (duty cycle): -
Welding amperage range: TIG 15-200 Amps / MMA 18V / 15-200 Amps / CUT 28V / 20-50 Amps /125V
No load voltage: -
Single pass weld: -
Weldable metals: Welds Steel, Stainless, Copper, Iron + more
Wire diameter range: -
Max spool size: -
Other Specifications: Refer to brochure or advertisement

ROSSWELDER



Process: ARC
Input power: 240V, 50Hz (15A plug)
Rated output (duty cycle): 35% @ 200A / 60% @ 160A / 100% @ 120A
Welding amperage range: 5-200 Amps
No load voltage: 72V
Single pass weld: -
Weldable metals: -
Wire diameter range: -
Max spool size: -
Other Specifications: Refer to brochure or advertisement

WELD-CT312



Process: TIG / MMA / CUT
Input power: 240V, 50Hz (15A plug)
Rated output (duty cycle):
Welding amperage range: TIG 10-120 Amps / MMA 20-120 Amps / CUT 20-30 Amps
No load voltage: -
Single pass weld: -
Weldable metals: -
Wire diameter range: -
Max spool size: -
Other Specifications: Refer to brochure or advertisement

WELD-CT416



Process: TIG / MMA / CUT
Input power: 240V, 50Hz (15A plug)
Rated output (duty cycle):
Welding amperage range: TIG 10-160 Amps / MMA 20-160 Amps / CUT 20-40 Amps
No load voltage: -
Single pass weld: -
Weldable metals: -
Wire diameter range: -
Max spool size: -
Other Specifications: Refer to brochure or advertisement

WELD-MIG185E



Process: MIG / MAG / MMA
Input power: 220-240V 50Hz (15A Plug)
Rated output (duty cycle): 180A-15%, 90A-60%
Welding amperage range: 60-185Amps (Max)
No load voltage: -
Single pass weld: -
Weldable metals: -
Wire diameter range: 0.8 - 1.0mm, 0.6 - 0.8mm
Max spool size: 5kg
Other Specifications: Refer to brochure or advertisement

WELD-MIG195-ORANGE



Process: MIG / MAG
Input power: 240V, 50Hz
Rated output (duty cycle):
Welding amperage range: 40-200Amps (Max)
No load voltage: 23-38V
Single pass weld: -
Weldable metals: -
Wire diameter range: 0.6mm - 1.0mm
Max spool size: 5kg
Other Specifications: Refer to brochure or advertisement

WELD-MIG220BZ



Process: MIG/MAG/TIG/MMA
Input power: 220-240V 50Hz (15A Plug) +/- 15%
Rated output (duty cycle): -
Welding amperage range: 50-220A
No load voltage: 38
Single pass weld: -
Weldable metals: -
Wire diameter range: 0.8-1.0mm
Max spool size: 2.5kg
Other Specifications: Refer to brochure or advertisement

WELD-ROSSI-205TC



Process: TIG/CUT/MMA
Input power: 240V, 50Hz
Rated output (duty cycle): TIG 60%@200Amps / MMA 35%@160Amps
Welding amperage range: TIG 10-200Amps / MMA 10-160Amps
No load voltage: -
Single pass weld: -
Weldable metals: -
Wire diameter range: -
Max spool size: 5kg
Other Specifications: Refer to brochure or advertisement

WELD-ROSSI-MT200



Process: MIG/TIG/MMA
Input power: 240V, 50Hz (15A)
Rated output (duty cycle):
Welding amperage range: MIG 30-200A
No load voltage: 60
Single pass weld: -
Weldable metals: -
Wire diameter range: -
Max spool size: 1Kg
Other Specifications: Refer to brochure or advertisement

WELD-WSM200



Process: TIG/MMA
Input power: 240V, 50Hz (15A Plug)
Rated output (duty cycle):
Welding amperage range: MMA 5-160Amps / TIG 10-200 Amps @ 18V
No load voltage: -
Single pass weld: -
Weldable metals: -
Wire diameter range: NA
Max spool size: NA
Other Specifications: Refer to brochure or advertisement

WLDMIG155RSSADJE



Process: MIG/MAG
Input power: 240V, 50Hz (15A Plug)
Rated output (duty cycle): 155A-10%, 62A-60%, 50A-100%
Welding amperage range: 30-155Amps (Max)
No load voltage: 23-38V
Single pass weld: -
Weldable metals: -
Wire diameter range: NA
Max spool size: NA
Other Specifications: Refer to brochure or advertisement

WLDMIG185RSSADJE



Process: MIG/MAG
Input power: 240V, 50Hz (15A Plug)
Rated output (duty cycle): 185a-10%, 68a-60%, 55a-100%
Welding amperage range: 40-185Amps (Max)
No load voltage: 33V
Single pass weld: -
Weldable metals: -
Wire diameter range: 0.6-0.8mm to 0.8-1.0mm
Max spool size: 5kg
Other Specifications: Refer to brochure or advertisement

WLDMIG195RSSADJE



Process: MIG/ MAG/ MMA
Input power: 240V, 50Hz (15A Plug)
Rated output (duty cycle): 195a-10%, 74a-60%, 60a-100%
Welding amperage range: 40-195Amps (Max)
No load voltage: 33V
Single pass weld: -
Weldable metals: -
Wire diameter range: 0.6-0.8mm to 0.8-1.0mm
Max spool size: 5kg
Other Specifications: Refer to brochure or advertisement

WLDPAA200ROSADJB



Process: AC/DC/TIG
Input power: 240V, 50Hz (15A Plug)
Rated output (duty cycle): TIG 60%@200Amps / MMA 35%@160Amps / Plasma Cutter 60%@50Amps
Welding amperage range: MMA 10-160A / Plasma Cutter 15-50A
No load voltage: -
Single pass weld: -
Weldable metals: -
Wire diameter range: NA
Max spool size: NA
Other Specifications: Refer to brochure or advertisement

WLDMIGROSA130



Input power voltage (V): 240V, 50Hz
Wire Spool Diameter: 0.6 - 0.9mm
Spool Capacity: 1kg
Current Range: 30-130Amps (Max)
Welder Type: Gas/Gasless Metal Inert/Active Gas (MIG/MAG)
Duty Cycle: 125A-20%, 96A-35%, 74A-60%
Power Plug: 15A

WLDMIG280BROS



Input power voltage (V): 220-240V 50Hz (15A Plug)
Input Capacity: 6.1KVA
Current Range: 50-280Amps (Max)
Welder Type: Metal Inert Gas/Metal Active Gas (MIG/MAG) and Manual Metal Arc (MMA/ARC)
Welding spool: 0.6 - 1.0mm
Duty Cycle: 280A-12%, 89A-100%
Power Plug: 15 Amp

WLDPTAROSA620



Rated Input Voltage: AC240V+15%
Input Capacity: 7.1KVA
Frequency: 50/60HZ
No-load Loss: 40W
Power Factor: 0.93
Efficiency: 85%
Class of Insulation: B
Case Protection Degree: IP21
Power Plug: 10A
Input Current TIG: 21A MMA: 32A CUT: 28.6A
Rated Output Current TIG: 200A MMA: 200A CUT: 50A
Current Range TIG: 15-200A MMA: 15-200A CUT: 20-50A
No-load Voltage TIG: 62V MMA: 62V CUT: 250V
Working Voltage TIG: 18V MMA: 28V CUT: 125V
Nozzle Internal: 1.3mm
Air Pressure: 0.45MPA
Gas Flow TIG: 2-5L/min CUT: 80L/min
Cut Thickness: 1-12mm
Arc-leading TIG: HF Vibrate MMA: Touch CUT: HF Vibrate

WELD-CUT40



Input Voltage: 220-240V 50Hz (10A Plug)
Output Current: 20-40 Amps
Post Flow Timer: 2.5-5 Seconds
Output Voltage: 100V
Duty Cycle: 60%
Input Air Pressure: 0.45Mpa
Cutting Capacity: 1-8mm
Pilot Arc Mode: HF
Efficiency: 85%
GENERATOR SAFE - 5.5kVA recommended
Power Plug: Australian Standard

WELD-CT312



Input Voltage: 240V 50Hz (10A Plug) +/- 15%
Output:
TIG: 10-120 Amps
MMA: 20-120 Amps
CUT: 20-30 Amps
Duty Cycle: 60%
Input Air Pressure: 0.4Mpa
Cutting Capacity: 1-9mm
Rod Capacity: 4mm
Pilot Arc Mode: HF
Efficiency: 85%
Generator Safe - 5.5kVA recommended
Power Plug: Australian Standard

WLDMIG185BROS



Input power voltage: 240V, 10amp, 50Hz
Current Range: 40-185A (Max)
Welder Type: Metal in Gas (MIG/MAG) and Manual Metal Arc (MMA/ARC)
Operation: Gas and Gasless
No Load Voltage: 33V
Duty Cycle: 185a-14%, 69A-100%
Insulation Class: IP21
Note: This welder can be used with flux wire/ CO2 wire

WLDMIG195BROS



Input power voltage (V): 240V, 50Hz
Current Range: 40-195Amps (Max)
Welder Type: Metal in Gas (MIG/MAG) and Manual Metal Arc (MMA/ARC)
Operation: Gas and Gasless
No Load Voltage: 33V
Insulation Class: IP21
Power Plug: 10A Australian Standard
Torch Cable: 2.1m
Earth Lead Cable: 2m
Electrode Holder Cable: 2m
Note: This welder can be used with flux wire/ CO2 wire

WLDPTAROSA160



Power Voltage: 240V 50Hz
No-Load Voltage: 50V
Output Current Range: 20-160 Amps
Protection Class: IP21
Duty Cycle: 60% @ 160A / 100% @ 130A
Power Plug: 15A
Power Plug: Australian Standard

WLDMPTROS416



Input Voltage: 240V 50Hz
TIG (Amps/Duty Cycle): 123A @ 100%, 160A @ 60%
MMA (Amps/Duty Cycle): 123A @ 100%, 160A @ 60%
CUT: 20-40 Amps @ 60% Duty Cycle
Operating Temp: -5 to +40°C
Transportation Temp: -20 to +55°C
Input Air Pressure: 0.4Mpa
Cutting Capacity: 1-12mm
Rod Capacity: 4mm
Pilot Arc Mode: HF
Efficiency: 85%
Plug: 10A
Generator Safe - 8kVA recommended
Power Plug: Australian Standard

WLDMIGROSA220



Input Voltage: 220-240V 50Hz (10A Plug) +/- 15%
No Load Voltage (V): 38
Input Capacity: 7.5KVa
Output Current: 50-220A
Wire Spool Diameter: 0.6mm- 0.8mm
Torch Length: 1.6m
Insulation Class: F
Spool Capacity: 2.5kg
Rod Capacity: 4mm
Max Rated Input: 10 Amp (Require 10Amp Socket)
Duty Cycle: 30% @ 220A
Efficiency: 85%
Generator Safe - 8kVA recommended
Power Plug: Australian Standard

WLDMMAROSB200



Voltage: 240V 50Hz (15A Plug)
No-Load Voltage: 72V
Output Current Range: 20-200 Amps
Protection Class: IP21
Duty Cycle: 30% @ 200A 100% @ 108A
No-load Power: 62W
Single Pass Weld: 2-6mm
Weldable metals: Stainless Steel, Carbon Steel and Cast Steel
Wire diameter range: 1.6-2.5mm
Power Factor: COS 0.93
Generator Recommended: 5.5kVA
Power Plug: 15A

WLDWSMROSA200



Input Voltage: 240V 50Hz (15A Plug)
Output: TIG 10-200 Amps / 18V
MMA 5-160 Amps
Duty Cycle: 60%
Protection Class: IP21
Pilot Arc Mode: HF
Air Hose Fitting: 1/4"
Efficiency: 85%
Generator Safe: 5.5kVA recommended
Power Plug: Australian Standard

WLDMIGROSA1C7



Voltage: 240V 50Hz (15A Plug)
Output Current Range: 20 - 170 Amps
Protection Class: IP21
Duty Cycle: 38% @ 170A
No-Load Power: 50W
Weldable Metals: Stainless Steel, Steel, Cast Iron, Aluminium and Alloys
Wire Diameter Range: 0.6-0.8mm (1kg spool)
Suitable electrodes: 1.6-4.0mm
Electrode Cord Length: 1.8m
Power Factor: COS 0.93
Generator Recommended: 4.6kVA
Power cord length: 1.8m
Power Plug: 15A

Glossary

AC Welders – Aluminium & Magnesium

DC Welders – All other metals

Arc Force – This function enables operators to tailor the shape of the volt/amp curve to better suit the different joint configurations and electrode types.

DCEP – Reverse Polarity

DCEN – Straight Polarity

AC Balance – Alternating current contains both electrode positive and electrode negative changing rapidly back and forth. With Old school machines, you get what you get and roughly 50 /50 dcep/dcen...and you don't always need all that cleaning action that you get from the dcep but with most TIG inverters, you can adjust the ac balance to more than 90 % dcen. Rule of thumb: for nasty aluminium like a boat prop that has some corrosion, adjust the ac balance to where you use more dcep .For brand new clean aluminium diamond plate, set the ac balance to where you have around 70-80 percent dcen.

AC Frequency – power from the power company is roughly 50-60 Hz in different countries. An inverter steps the frequency of the incoming AC power up before it even converts it to DC. That's why the transformer is so small light compared to older TIG welders the A/C frequency knob allows you to weld with a much higher frequency. That option stiffens and focuses the TIG welding arc pinpoints the heat.

Basic current / Base current (Amperage) - The amount of electricity flowing past a point in a conductor every second.

Clean area width (Phase Balance) – Applies to AC welding and sets the proportion of time the weld current is positive, during which time the current has an "oxide penetrating" effect on the aluminium alloy weld pool surface, but which also tends to heat up and melt the tungsten electrode rather than the weld pool. Maximum heat is delivered to the work piece/job when the electrode is negative so this setting is used to achieve the best compromise when welding ally.

Down-Slope Time – Allows the current to decrease at whatever rate you set on the knob.

Peak current – Peak current is the nominal current for the high energy pulse. It is adjusted to a level that is set consistently above the globular to spray transition current. Peak current is expressed in units of ampere. During the time when the peak current is delivered, the molten droplet detaches from the electrode. An increase in peak current increases the average welding current and the weld penetration.

Pre flow - The length of time the torch gas flows before the arc terminates.

Post Gas – The length of time the torch gas flows after the arc terminates.

Pulse Duty (duty cycle) – The number of minutes out of a 10-minute time period an arc welding machine can be operated at maximum rated output. An example would be 60% duty cycle at 300 amps. This would mean that at 300 amps the welding machine can be used for 6 minutes and then must be allowed to cool with the fan motor running for 4 minutes.

Pulse Frequency – The sequencing and controlling of the amount of current, frequency and duration of the welding arc.

Pulse width (Pule % on time) - The time the high pulse amperage stays on.

Up-Slope Time – Allows the current to climb at whatever rate you set...from start amperage to operating main amperage setting on the machine

Wire Speed / Speed – The speed at which wire is fed out of the machine.

2T - for using a switch on the torch handle...when you plug in the foot pedal or torch amperage control, most TIG inverters are designed to bypass the 2t and 4t settings because the amperage control overrides all the upslope and downslope stuff. The 2t setting pretty much turns the torch switch into a 2 position switch. Press the switch, you get and arc, let off the switch, arc goes out.

4T - The 4T position is most always used in conjunction with upslope and downslope settings. For example;

- a. Press the button and you get an arc.
- b. Let off the button and the arc upslope to whatever the main amperage is set to Weld.
- c. Press the button and arc downslopes to lower amperage
- d. Let off the button and arc quits.
- e. Some machines are different but this is the general principle of 4t operation

Start Amps - allows for a really low amperage start-up or a hot one

End Amps - determines the final amperage before the arc quits.



Some experts believe that the incorrect or prolonged use of almost any product may cause serious injury or death. To help reduce your risk of serious injury or death, refer to the information below. For more information, see www.datastreamserver.com/safety

- Consult all documentation, packaging and product labelling before use. Note that some products feature documentation available online. It is recommended to print and retain the documentation.
- Before each use, check the product for loose/broken/damaged/missing parts, wear or leaks (if applicable). Never use a product with loose/broken/damaged/missing parts, wear or leaks.
- Products must be inspected and serviced (if applicable) by a qualified technician every 6 months. This is based on average residential use by persons of average size and strength, and on a property of average metropolitan size. Use beyond these recommendations may require more frequent inspections/servicing.
- Ensure that all users of the product have completed a suitable industry recognised training course before being allowed access to the product.
- The product has been supplied by a general merchandise retailer that may not be familiar with your specific application or description of application. Be sure to attain third-party approval from a qualified specialist for your application before use, regardless of any assurances from the retailer or its representatives.
- This product is not intended for use where fail-safe operation is required. As with any product (for example, automobile, computer, toaster), there is the possibility of technical issues that may require the repair or replacement of parts, or the product itself. If the possibility of such failure and the associated time it may take to rectify could in any way inconvenience the user, business or employee, or financially affect the user, business or employee, then the product is not suitable for your requirements. This product is not intended for use where incorrect operation or a failure of any kind, including but not limited to, a condition requiring product return, replacement, parts replacement or service by a technician may cause financial loss, loss of employee time or an inconvenience requiring compensation.
- If this product has been purchased in error when considering the information presented here, contact the retailer directly for details of their returns policy, if required.

