

BULLET

PRO SERIES



Heavy Duty 3 Shelf Portable Tool Trolley Cart – BL-293M

Assembly Guide

[Revision 1.0 March 2019]

READ THIS MANUAL CAREFULLY BEFORE USE – FAILURE TO DO SO MAY RESULT IN INJURY, PROPERTY DAMAGE AND MAY VOID WARRANTY. • KEEP THIS MANUAL FOR FUTURE REFERENCE. • Products covered by this manual may vary in appearance, assembly, inclusions, specifications, description and packaging.

Safety

Safety messages are designed to alert you to possible dangers or hazards that could cause death, injury or equipment or property damage if not understood or followed. Safety messages have the following symbols:



You **WILL** be **KILLED** or **SERIOUSLY INJURED** if you do not follow instructions.



You **CAN** be **KILLED** or **SERIOUSLY INJURED** if you do not follow instructions.



You **CAN** be **INJURED** if you do not follow instructions or equipment damage may occur.

It is vital that you read and understand this user manual before using the product, including safety warnings, and any assembly and operating instructions. Keep the manual for future reference.

Safety precautions and recommendations detailed here must be fully understood and followed to reduce the risk of injury, fire, explosion, electrical hazard, and/or property damage.

Safety information presented here is generic in nature – some advice may not be applicable to every product. The term "equipment" refers to the product, be it electrical mains powered, battery powered or combustion engine powered.

- **Before Use** - If you are not familiar with the safe operation/handling of the equipment or are in any way unsure of any aspect of suitability or correct use for your application, you should complete training conducted by a person or organization qualified in safe use and operation of this equipment, including fuel/electrical handling and safety.
- Do NOT operate the equipment in flammable or explosive environments, such as in the presence of flammable liquids, gases or dust. The equipment may create sparks or heat that may ignite flammable substances.
- Keep clear of moving parts.
- Equipment may be a potential source of electric shock or injury if misused.
- Do NOT operate the equipment if it is damaged, malfunctioning or is in an excessively worn state.
- Do NOT allow others to use the equipment unless they have read this manual and are adequately trained.
- Keep packaging away from children - risk of suffocation! Operators must use the equipment correctly. When using the equipment, consider conditions and pay due care to persons and property.

General Work Area Safety

- Work areas should be clean and well lit.
- Do not operate the equipment if bystanders, animals etc are within operating range of the equipment or the general work area.
- If devices are provided for connecting dust extraction / collection facilities, ensure these are connected and used properly. Dust collection can reduce dust-related hazards.

General Personal Safety

- Wear appropriate protective equipment when operating, servicing, or when in the operating area of the equipment to help protect from eye and ear injury, poisoning, burns, cutting and crush injuries. Protective equipment such as safety goggles, respirators, non-slip safety footwear, hard hat, hearing protection etc should be used for appropriate equipment / conditions. Other people nearby should also wear appropriate personal protective equipment. Do not wear loose clothing or jewellery, which can be caught in moving parts. Keep hair and clothing away from the equipment.
- Stay alert and use common sense when operating the equipment. Do not over-reach. Always maintain secure footing and balance.
- Do not use the equipment if tired or under the influence of drugs, alcohol or medication.
- This equipment is not intended for use by persons with reduced physical, sensory or mental capabilities.

General Fuel Safety

- Petrol/fuel/gasoline is extremely flammable – keep clear of naked flames or other ignition sources.
- Do not spill fuel. If you spill fuel, wipe it off the equipment immediately – if fuel gets on your clothing, change clothing.
- Do NOT smoke near fuel or when refuelling.
- Always shut off the engine before refuelling.
- Do NOT refuel a hot engine.
- Open the fuel cap carefully to allow any pressure build-up in the tank to release slowly.
- Always refuel in well ventilated areas.
- Always check for fuel leakage. If fuel leakage is found, do not start or run the engine until all leaks are fixed.

General Carbon-Monoxide Safety

- Using a combustion engine indoors **CAN KILL IN MINUTES**. Engine exhaust contains carbon-monoxide – a poison you cannot smell or see.
- Use combustion engines **OUTSIDE** only, and far away from windows, doors and vents.

General Equipment Use and Care

- The equipment is designed for domestic use only.
- Handle the equipment safely and carefully.
- Before use, inspect the equipment for misalignment or binding of moving parts, loose components, damage or any other condition that may affect its operation. If damaged, have the equipment repaired by an authorised service centre or technician before use.
- Prevent unintentional starting of the equipment - ensure equipment and power switches are in the OFF position before connecting or moving equipment. Do not carry equipment with hands or fingers touching any controls. Remove any tools or other items that are not a part of the equipment from it before starting or switching on.
- Do not force the equipment. Use the correct equipment for your application. Equipment will perform better and be safer when used within its design and usage parameters.
- Use the equipment and accessories etc. in accordance with these instructions, considering working conditions and the work to be performed. Using the equipment for operations different from those intended could result in hazardous situations.
- Always keep equipment components (engines, hoses, handles, controls, frames, housings, guards etc) and accessories (cutting tools, nozzles, bits etc) properly maintained. Keep the equipment clean and, where applicable, properly lubricated.
- Store the equipment out of reach of children or untrained persons. To avoid burns or fire hazards, let the equipment cool completely before transporting or storing. Never place or store the equipment near flammable materials, combustible gases or liquids etc.
- The equipment is not weather-proof, and should not be stored in direct sunlight, at high ambient temperatures or locations that are damp or humid.
- Do not clean equipment with solvents, flammable liquids or harsh abrasives.
- For specific equipment safety use and care, see Equipment Safety.

General Electrical Safety

- Inspect electrical equipment, extension cords, power bars, and electrical fittings for damage or wear before each use. Repair or replace damaged equipment immediately.
- Ensure all power sources conform to equipment voltage requirements and are disconnected before connecting or disconnecting equipment.
- When wiring electrically powered equipment, follow all electrical and safety codes.
- Wherever possible, use a residual current device (RCD).
- High voltage / high current power lines may be present. Use extreme caution to avoid contact or interference with power lines. Electrical shock can be fatal.

General Electrical Safety





















- Electrically grounded equipment must have an approved cord and plug and be connected to a grounded electrical outlet.
- Do NOT bypass the ON/OFF switch and operate equipment by connecting and disconnecting the electrical cord.
- Do NOT use equipment that has exposed wiring, damaged switches, covers or guards.
- Do NOT use electrical equipment in wet conditions or in damp locations.
- Do NOT use electrical cords to lift, move or carry equipment.
- Do NOT coil or knot electrical cords, and ensure electrical cords are not trip hazards.

General Service Information

- The equipment must be serviced or repaired at authorised service centres by qualified personnel only.
- Replacement parts must be original equipment manufacturer (OEM) to ensure equipment safety is maintained.
- Do NOT attempt any maintenance or repair work not described in this manual.
- After use, the equipment and components may still be hot – allow the equipment to cool and disconnect spark plugs and/or electrical power sources and/or batteries from it before adjusting, changing accessories or performing repair or maintenance.
- Do NOT adjust while the equipment is running.
- Perform service related activities in suitable conditions, such as a workshop.
- Replace worn, damaged or missing warning/safety labels immediately.

Safety Symbols

The product may have safety warning labels attached to it, explained below. Understand the symbols on your product and their meanings. If any stickers become unreadable, unattached etc., replace them.

 <p>Flammable Material Hazard Flammable liquids, gases or substances etc may present. Avoid ignition sources and open flames. Danger of fire.</p>	 <p>Read User Manual Read and fully understand product safety warnings, operation, procedures etc before using the product.</p>	 <p>Use Hand Protection Wear appropriate hand protection and take due care as the product or use of the product may present hand hazards.</p>	 <p>Carbon-Monoxide Hazard Do not use the product in confined areas or without adequate ventilation. Carbon-monoxide poisoning can be fatal.</p>
 <p>Electrocution / Electrical Shock Hazard High voltage or high current electricity may be present or required by the product. Take due care when handling electrical products, cables, plugs and leads. Electrical shock can be fatal.</p>	 <p>Toxic Fumes / Dust Hazard Using the product or by-products from use may produce fumes, smoke or particles that could be harmful if inhaled. Wear appropriate breathing protection and have adequate ventilation.</p>	 <p>Explosive Material Hazard Combustible liquids, gases or substances etc may be present. Avoid ignition sources and open flames. Danger of explosion.</p>	 <p>Cutting / Amputation Hazard The product may have blades, edges or mechanical devices that can cause severe cut injury to fingers, limbs etc. Take due care when handling and using the product.</p>
 <p>Crush Hazard The product may have blades, edges or mechanical devices that can cause severe crush injury to fingers, limbs etc. Take due care when handling and using the product.</p>	 <p>Single Operator Only The product must be operated by a single person only. More than one person operating the product may introduce additional hazards.</p>	 <p>Use Face Protection Wear appropriate full-face protection and take due care as the product or use of the product may present face and eye hazards.</p>	 <p>Use Foot Protection Wear appropriate foot protection and take due care as the product or use of the product may present foot hazards.</p>
 <p>Use Eye / Ear / Head Protection Wear appropriate eye and / or ear and / or head protection and take due care as the product or use of the product may present eye, hearing and head hazards.</p>	 <p>Running Hazard Do not run on or near the product as doing so may present a fall hazard.</p>	 <p>Diving Hazard Do not dive into the product as doing so may present a neck / head injury hazard.</p>	 <p>Adult Supervision Required Always supervise children and other users of a product to prevent drowning or injury.</p>
 <p>Skin Penetration / Puncture Hazard The product may produce pressure, emit liquids or objects that can cause severe injury to fingers, limbs, blood etc. Take due care when handling and using the product.</p>	 <p>Hot Surface Hazard Be aware that the product may produce high temperatures and hot surfaces that can cause burn injuries.</p>	 <p>Flying Debris Hazard Be aware that the product or use of the product may present hazards produced by flying debris. Wear appropriate clothing and protective devices.</p>	 <p>Moving Parts Hazard Be aware that the product contains or uses mechanical devices that move or rotate. Always wait for moving parts to stop fully before handling the product, adjusting, maintenance etc.</p>















 <p>Carbon-Monoxide Hazard Do not use the product in confined areas or without adequate ventilation. Carbon-monoxide poisoning can be fatal.</p>	 <p>Pull Hazard Be aware that the product contains or uses mechanical devices that can pull in objects and can cause severe injury to fingers, limbs etc. Take due care when handling and using the product.</p>	 <p>Slope / Fall Injury Hazard Be aware that using the product on sloping surfaces or in slippery conditions may present additional dangers from falls and contact with blades, moving parts, hot surfaces etc.</p>	 <p>"Slam Dunk" Warning Do NOT attempt "slam dunk" manoeuvres as this may result in severe injury due to falling, product breakage or collapse etc.</p>
 <p>Electrocution / Electrical Shock Hazard - Outdoor High voltage or high current electricity may be present or required by the product. Do NOT use in rain, damp or wet conditions. Electrical shock can be fatal.</p>	 <p>Electrocution / Electrical Shock Hazard - Disconnect High voltage or high current electricity may be present or required by the product. Always disconnect the product from the electrical supply before handling the product, adjusting, maintenance etc.</p>	 <p>Power Line Electrocution Hazard High voltage / high current power lines may be present. Use extreme caution to avoid contact or interference with power lines. Electrical shock can be fatal.</p>	 <p>"Kick-Back" Hazard High level of "kick-back" hazard that can cause the machine to suddenly rotate towards operator. Kick-back injury can be fatal.</p>
 <p>Winch Operator Position Hazard Do NOT stand between winch and load. Do NOT use winch to move people.</p>	 <p>Winch Lift Hazard Do NOT LIFT load vertically. Use machine to PULL only.</p>	 <p>Cable Hazard Ensure that load bearing cable is not kinked or knotted.</p>	 <p>Winch Cable Hazard Ensure that there is a minimum number of cable coils on winching mechanism.</p>
 <p>Winch Hook Hazard Carry hook to load – do NOT throw or run.</p>	 <p>Flash / Blinding Hazard Wear appropriate eye protection for welding. Direct exposure to weld arcs may cause permanent eye injury.</p>	 <p>Laser Hazard Laser may be in use – do NOT look directly at laser or allow others to.</p>	

Table of Contents

Safety	2
Safety Symbols	4
Parts List	7
Assembly	8
Specifications	9

Parts List

Parts	Qty.
Tray	3
Pillar	4
Peg board	1
Side panel	2
Wheel	4
Packages for screws: <ul style="list-style-type: none">▪ 1 package for wheels▪ 1 package for trays and pillars	2
Handle	1

Assembly

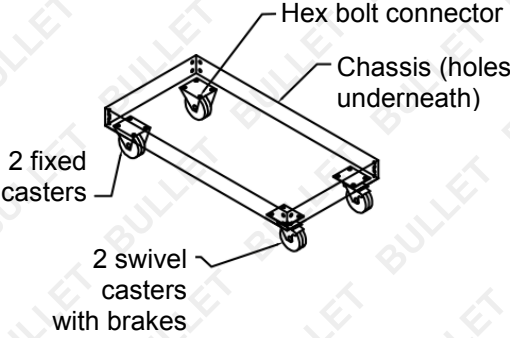
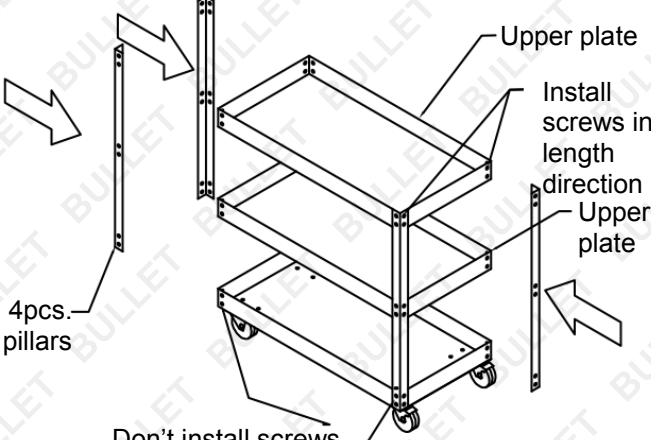
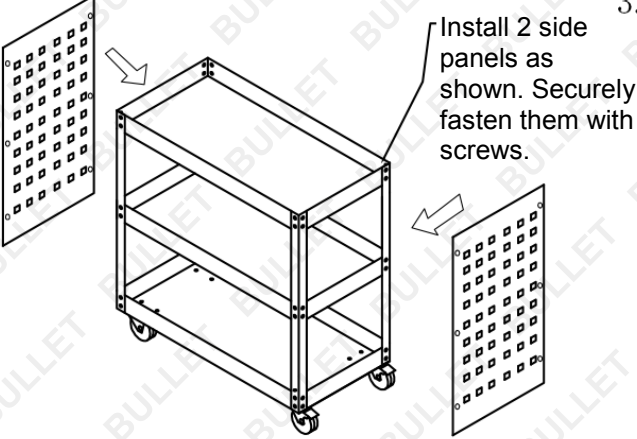
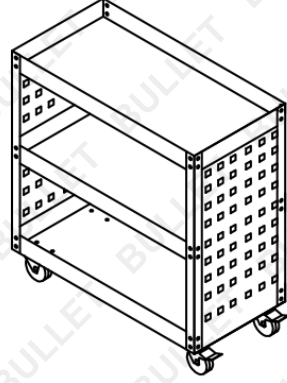
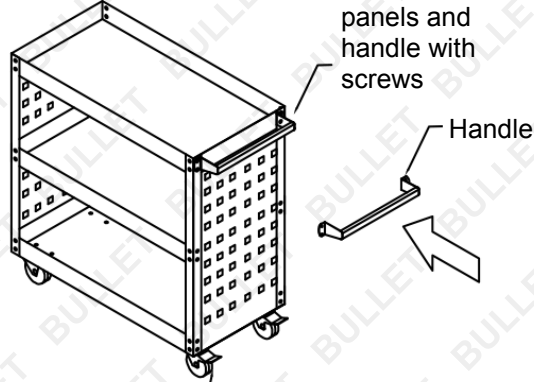
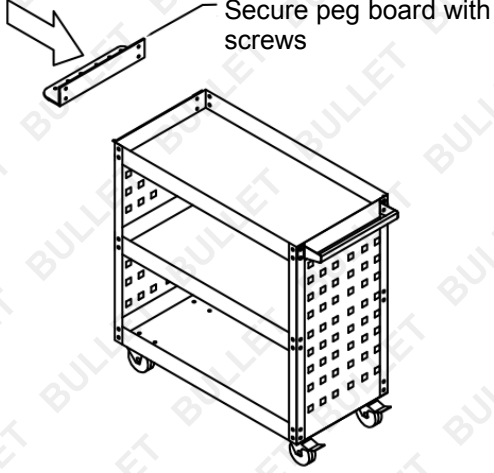
 <p>Hex bolt connector Chassis (holes underneath) 2 fixed casters 2 swivel casters with brakes</p> <p>1.</p>	 <p>Upper plate Install screws in length direction Upper plate 4 pcs. pillars Don't install screws in width direction</p> <p>2.</p>
 <p>Install 2 side panels as shown. Securely fasten them with screws.</p> <p>3.</p>	 <p>4.</p>
 <p>Secure side panels and handle with screws Handle Swivel casters and handle must be on the same side</p> <p>5.</p>	 <p>Secure peg board with screws</p> <p>6.</p>

Heavy Duty 3 Shelf Portable Tool Trolley Cart – BL-293M

1. Connect the casters to the chassis, the directional wheel and the swivel wheel should be on opposite sides, not on the same sides. Use hex screws to secure them.
2. Install the pillars. Connect the pillars and the tray with round head screws, as shown in the image above. Don't assemble the two side panels yet.
3. Install the side panels as shown in the image above.
4. Install the handle, Securing it to the top two screw holes with screws.
5. Install the peg board and secure it with screws.

Specifications

Frame	Powder Coated Solid Steel
Deep Shelves	3



Some experts believe that the incorrect or prolonged use of almost any product may cause serious injury or death. To help reduce your risk of serious injury or death, refer to the information below. For more information, see www.datastreamserver.com/safety

- Consult all documentation, packaging and product labelling before use. Note that some products feature documentation available online. It is recommended to print and retain the documentation.
- Before each use, check the product for loose/broken/damaged/missing parts, wear or leaks (if applicable). Never use a product with loose/broken/damaged/missing parts, wear or leaks.
- Products must be inspected and serviced (if applicable) by a qualified technician every 6 months. This is based on average residential use by persons of average size and strength, and on a property of average metropolitan size. Use beyond these recommendations may require more frequent inspections/servicing.
- Ensure that all users of the product have completed a suitable industry recognised training course before being allowed access to the product.
- The product has been supplied by a general merchandise retailer that may not be familiar with your specific application or description of application. Be sure to attain third-party approval from a qualified specialist for your application before use, regardless of any assurances from the retailer or its representatives.
- This product is not intended for use where fail-safe operation is required. As with any product (for example, automobile, computer, toaster), there is the possibility of technical issues that may require the repair or replacement of parts, or the product itself. If the possibility of such failure and the associated time it may take to rectify could in any way inconvenience the user, business or employee, or financially affect the user, business or employee, then the product is not suitable for your requirements. This product is not intended for use where incorrect operation or a failure of any kind, including but not limited to, a condition requiring product return, replacement, parts replacement or service by a technician may cause financial loss, loss of employee time or an inconvenience requiring compensation.
- If this product has been purchased in error when considering the information presented here, contact the retailer directly for details of their returns policy, if required.

